



**CY7C460**  
**CY7C462**  
**CY7C464**

**Cascadable 8K x 9 FIFO**  
**Cascadable 16K x 9 FIFO**  
**Cascadable 32K x 9 FIFO**

**Features**

- 8K x 9 FIFO (CY7C460)
- 16K x 9 FIFO (CY7C462)
- 32K x 9 FIFO (CY7C464)
- Asynchronous read/write
- High-speed 33.3-MHz read/write independent of depth/width
- Low operating power  
—  $I_{CC} = 70$  mA (max.)
- Half Full flag in standalone
- Empty and Full flags
- Retransmit in standalone
- Expandable in width and depth
- $5V \pm 10\%$  supply
- PLCC, LCC, and 600-mil DIP packaging
- TTL compatible
- Three-state outputs
- Pin compatible and functionally equivalent to IDT7205, IDT7206

**Functional Description**

The CY7C460, CY7C462, and CY7C464 are respectively, 8K, 16K, and 32K words by 9-bit wide first-in-first-out (FIFO) memories. Each FIFO memory is organized such that the data is read in the same sequential order that it was written. Full and Empty flags are provided to prevent overrun and underrun. Three additional pins are also provided to facilitate unlimited expansion in width, depth, or both. The depth expansion technique steers the control signals from one device to another in parallel, thus eliminating the serial addition of propagation delays, so that throughput is not reduced. Data is steered in a similar manner.

The read and write operations may be asynchronous; each can occur at a rate of 33.3 MHz. The write operation occurs when the write ( $\bar{W}$ ) signal is LOW. Read occurs when read ( $\bar{R}$ ) goes LOW. The nine

data outputs go to the high-impedance state when  $\bar{R}$  is HIGH.

A Half Full ( $\bar{HF}$ ) output flag is provided that is valid in the standalone (single device) and width expansion configurations. In the depth expansion configuration, this pin provides the expansion out ( $\bar{XO}$ ) information that is used to tell the next FIFO that it will be activated.

In the standalone and width expansion configurations, a LOW on the retransmit ( $\bar{RT}$ ) input causes the FIFOs to retransmit the data. Read enable ( $\bar{R}$ ) and write enable ( $\bar{W}$ ) must both be HIGH during a retransmit cycle, and then  $\bar{R}$  is used to access the data.

The CY7C460, CY7C462, and CY7C464 are fabricated using an advanced 0.8-micron N-well CMOS technology. Input ESD protection is greater than 2000V and latch-up is prevented by careful layout, guard rings, and a substrate bias generator.

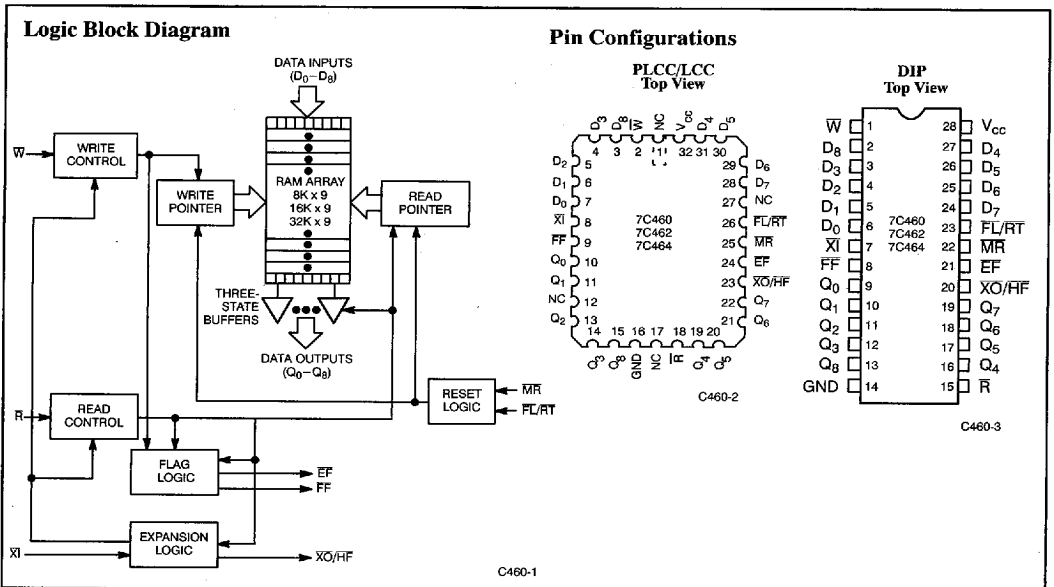

■ 2589662 0015496 331 ■



**Selection Guide**

	7C460-15 7C462-15 7C464-15	7C460-20 7C462-20 7C464-20	7C460-25 7C462-25 7C464-25	7C460-40 7C462-40 7C464-40	7C460-65 7C462-65 7C464-65
Frequency (MHz)	33.3	33.3	28.5	20	12.5
Maximum Access Time (ns)	15	20	25	40	65
Maximum Operating Current (mA)	Commercial	105	90	70	70
	Military		110	95	75

**Maximum Ratings**

(Above which the useful life may be impaired. For user guidelines, not tested.)

Storage Temperature ..... -65°C to +150°C  
 Ambient Temperature with Power Applied ..... -55°C to +125°C  
 Supply Voltage to Ground Potential ..... -0.5V to +7.0V  
 DC Voltage Applied to Outputs in High Z State ..... -0.5V to +7.0V  
 DC Input Voltage ..... -3.0V to +7.0V  
 Power Dissipation ..... 1.0W  
 Output Current, into Outputs (LOW) ..... 20 mA

Static Discharge Voltage ..... > 2001V (per MIL-STD-883, Method 3015)

Latch-Up Current ..... > 200 mA

**Operating Range**

Range	Ambient Temperature	V <sub>CC</sub>
Commercial	0°C to +70°C	5V ± 10%
Industrial	-40°C to +85°C	5V ± 10%
Military <sup>[1]</sup>	-55°C to +125°C	5V ± 10%

5

**Electrical Characteristics Over the Operating Range<sup>[2]</sup>**

Parameter	Description	Test Conditions	7C460-15 7C462-15 7C464-15		7C460-20 7C462-20 7C464-20		7C460-25 7C462-25 7C464-25		Unit
			Min.	Max.	Min.	Max.	Min.	Max.	
V <sub>OH</sub>	Output HIGH Voltage	V <sub>CC</sub> = Min., I <sub>OH</sub> = -2.0 mA	2.4		2.4		2.4		V
V <sub>OL</sub>	Output LOW Voltage	V <sub>CC</sub> = Min., I <sub>OL</sub> = 8.0 mA		0.4		0.4		0.4	V
V <sub>IH</sub>	Input HIGH Voltage		Com'l	2.2			2.2		V
			Mil/Ind			2.2		2.2	
V <sub>IL</sub>	Input LOW Voltage			0.8		0.8		0.8	V
I <sub>Ix</sub>	Input Leakage Current	GND ≤ V <sub>I</sub> ≤ V <sub>CC</sub>	-10	+10	-10	+10	-10	+10	µA
I <sub>OZ</sub>	Output Leakage Current	R ≥ V <sub>IH</sub> , GND ≤ V <sub>O</sub> ≤ V <sub>CC</sub>	-10	+10	-10	+10	-10	+10	µA
I <sub>CC</sub>	Operating Current	V <sub>CC</sub> = Max., I <sub>OUT</sub> = 0 mA	Com'l	105			90		mA
			Mil/Ind			110		95	
I <sub>SB1</sub>	Standby Current	All Inputs = V <sub>IH</sub> Min.	Com'l	25			25		mA
			Mil/Ind			30		30	
I <sub>SB2</sub>	Power-Down Current	All Inputs V <sub>CC</sub> - 0.2V	Com'l	20			20		mA
			Mil/Ind			25		25	
I <sub>OS</sub>	Output Short Circuit Current <sup>[3]</sup>	V <sub>CC</sub> = Max., V <sub>OUT</sub> = GND		-90		-90		-90	mA

**Notes:**

1. T<sub>A</sub> is the "instant on" case temperature.
2. See the last page of this specification for Group A subgroup testing information.
3. For test purposes, not more than one output at a time should be shorted. Short circuit test duration should not exceed 1 second.

2589662 0015497 278

**Electrical Characteristics Over the Operating Range (continued)<sup>[2]</sup>**

Parameter	Description	Test Conditions	7C460-40 7C462-40 7C464-40		7C460-65 7C462-65 7C464-65		Unit
			Min.	Max.	Min.	Max.	
V <sub>OH</sub>	Output HIGH Voltage	V <sub>CC</sub> = Min., I <sub>OH</sub> = -2.0 mA	2.4		2.4		V
V <sub>OL</sub>	Output LOW Voltage	V <sub>CC</sub> = Min., I <sub>OL</sub> = 8.0 mA		0.4		0.4	V
V <sub>IH</sub>	Input HIGH Voltage		Com'l		2.2		V
			Mil/Ind		2.2		
V <sub>IL</sub>	Input LOW Voltage			0.8		0.8	V
I <sub>IX</sub>	Input Leakage Current	GND ≤ V <sub>I</sub> ≤ V <sub>CC</sub>	-10	+10	-10	+10	μA
I <sub>OZ</sub>	Output Leakage Current	R ≥ V <sub>IH</sub> , GND ≤ V <sub>O</sub> ≤ V <sub>CC</sub>	-10	+10	-10	+10	μA
I <sub>CC</sub>	Operating Current	V <sub>CC</sub> = Max., I <sub>OUT</sub> = 0 mA	Com'l	70	70		mA
			Mil/Ind	75			
I <sub>SB1</sub>	Standby Current	All Inputs = V <sub>IH</sub> Min.	Com'l	25	25		mA
			Mil/Ind	30	30		
I <sub>SB2</sub>	Power-Down Current	All Inputs V <sub>CC</sub> - 0.2V	Com'l	20	20		mA
			Mil/Ind	25	25		
I <sub>OS</sub>	Output Short Circuit Current <sup>[3]</sup>	V <sub>CC</sub> = Max., V <sub>OUT</sub> = GND		-90		-90	mA

**Capacitance<sup>[4]</sup>**

Parameter	Description	Test Conditions	Max.	Unit
C <sub>IN</sub>	Input Capacitance	T <sub>A</sub> = 25°C, f = 1 MHz, V <sub>CC</sub> = 4.5V	10	pF
C <sub>OUT</sub>	Output Capacitance		12	pF

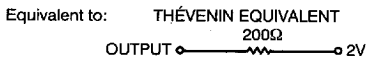
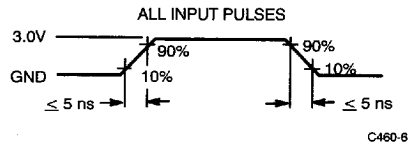
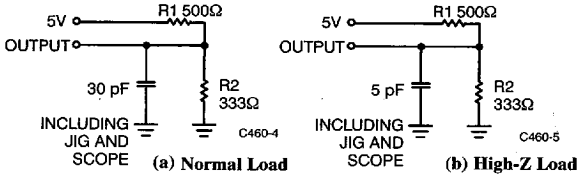
**AC Test Loads and Waveforms**

**Notes:**

4. Tested initially and after any design or process changes that may affect these parameters.

**Switching Characteristics Over the Operating Range<sup>[2, 5]</sup>**

Parameter	Description	7C460-15 7C462-15 7C464-15		7C460-20 7C462-20 7C464-20		7C460-25 7C462-25 7C464-25		7C460-40 7C462-40 7C464-40		7C460-65 7C462-65 7C464-65		Unit
		Min.	Max.	Min.	Max.	Min.	Max.	Min.	Max.	Min.	Max.	
t <sub>RC</sub>	Read Cycle Time	30		30		35		50		80		ns
t <sub>A</sub>	Access Time		15		20		25		40		65	ns
t <sub>RR</sub>	Read Recovery Time	15		10		10		10		15		ns
t <sub>PR</sub>	Read Pulse Width	15		20		25		40		65		ns
t <sub>LZR</sub>	Read LOW to Low Z	3		3		3		3		3		ns
t <sub>DVR</sub> <sup>[6]</sup>	Data Valid After Read HIGH	3		3		3		3		3		ns
t <sub>HZR</sub> <sup>[6]</sup>	Read HIGH to High Z		15		15		18		25		25	ns
t <sub>WC</sub>	Write Cycle Time	30		30		35		50		80		ns
t <sub>PW</sub>	Write Pulse Width	15		20		25		40		65		ns
t <sub>HWZ</sub>	Write HIGH to Low Z	5		5		5		5		5		ns
t <sub>WR</sub>	Write Recovery Time	15		10		10		10		15		ns
t <sub>SD</sub>	Data Set-Up Time	11		12		15		20		30		ns
t <sub>HD</sub>	Data Hold Time	0		0		0		0		10		ns
t <sub>MRS</sub>	MR Cycle Time	30		30		35		50		80		ns
t <sub>PMR</sub>	MR Pulse Width	15		20		25		40		65		ns
t <sub>MR</sub>	MR Recovery Time	15		10		10		10		15		ns
t <sub>RPW</sub>	Read HIGH to MR HIGH	15		20		25		40		65		ns
t <sub>WPW</sub>	Write HIGH to MR HIGH	15		20		25		40		65		ns
t <sub>RTC</sub>	Retransmit Cycle Time	30		30		35		50		80		ns
t <sub>PRT</sub>	Retransmit Pulse Width	15		20		25		40		65		ns
t <sub>RT</sub>	Retransmit Recovery Time	15		10		10		10		15		ns
t <sub>EFL</sub>	MR to EF LOW		25		30		35		50		80	ns
t <sub>HFH</sub>	MR to HF HIGH		25		30		35		50		80	ns
t <sub>FFH</sub>	MR to FF HIGH		25		30		35		50		80	ns
t <sub>REF</sub>	Read LOW to EF LOW		15		20		25		40		60	ns
t <sub>RFF</sub>	Read HIGH to FF HIGH		15		20		25		40		60	ns
t <sub>WEF</sub>	Write HIGH to EF HIGH		15		20		25		40		60	ns
t <sub>WFF</sub>	Write LOW to FF LOW		15		20		25		40		60	ns
t <sub>WHF</sub>	Write LOW to HF LOW		25		30		35		50		60	ns
t <sub>RHF</sub>	Read HIGH to HF HIGH		25		30		35		50		60	ns
t <sub>RAE</sub>	Effective Read from Write HIGH		15		20		25		40		60	ns
t <sub>RPE</sub>	Effective Read Pulse Width After EF HIGH	15		20		25		40		65		ns
t <sub>WAF</sub>	Effective Write from Read HIGH		15		20		25		40		60	ns
t <sub>WPF</sub>	Effective Write Pulse Width After FF HIGH	15		20		25		40		65		ns
t <sub>XOL</sub>	Expansion Out LOW Delay from Clock		15		20		25		40		65	ns
t <sub>XOH</sub>	Expansion Out HIGH Delay from Clock		30		35		35		50		65	ns

**Notes:**

5. Test conditions assume signal transmission time of 5 ns or less, timing reference levels of 1.5V and output loading of the specified I<sub>OL</sub>/I<sub>OH</sub> and 30-pF load capacitance, as in part (a) of AC Test Load, unless otherwise specified.
6. t<sub>HZR</sub> and t<sub>DVR</sub> use capacitance loading as in part (b) of AC Test Load.

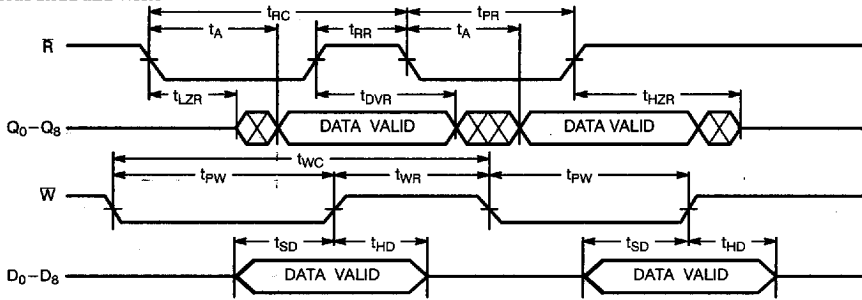
**Switching Waveforms<sup>[7]</sup>**
**Asynchronous Read and Write**

C460-7

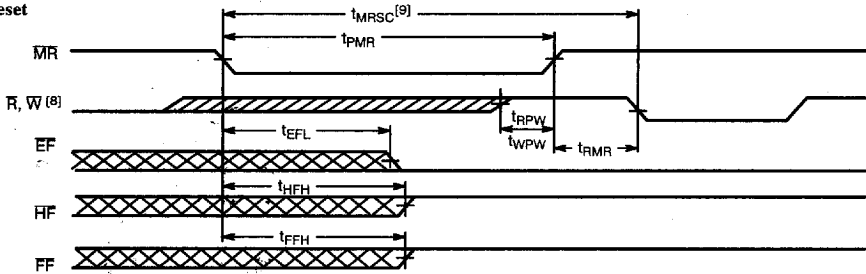
**Master Reset**

C460-8

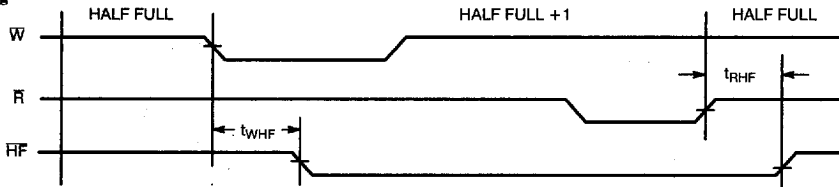
**Half Full Flag**

C460-9

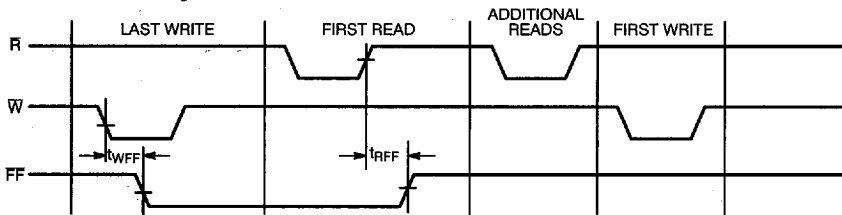
**Last Write to First Read Full Flag**

C460-10

**Notes:**

7. A HIGH-to-LOW transition of either the write or read strobe causes a HIGH-to-LOW transition of the responding flag. Correspondingly, a LOW-to-HIGH strobe transition causes a LOW-to-HIGH flag transition.
8.  $\bar{W}$  and  $\bar{R} = V_{IH}$  around the rising edge of  $\bar{MR}$ .
9.  $t_{MRSC} = t_{PMR} + t_{RMR}$ .

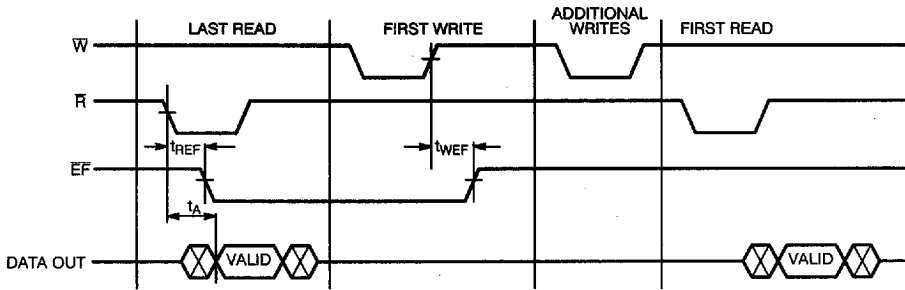
**Switching Waveforms**
**Last READ to First WRITE Empty Flag**

C460-11

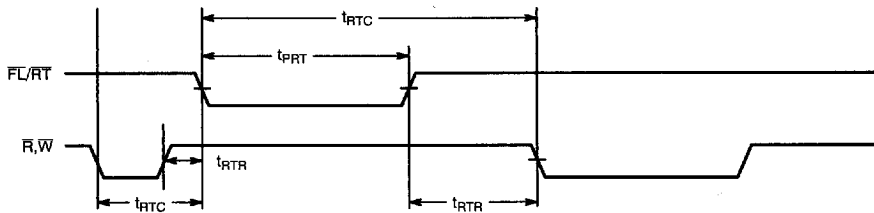
**Retransmit<sup>[10, 11]</sup>**

C460-12

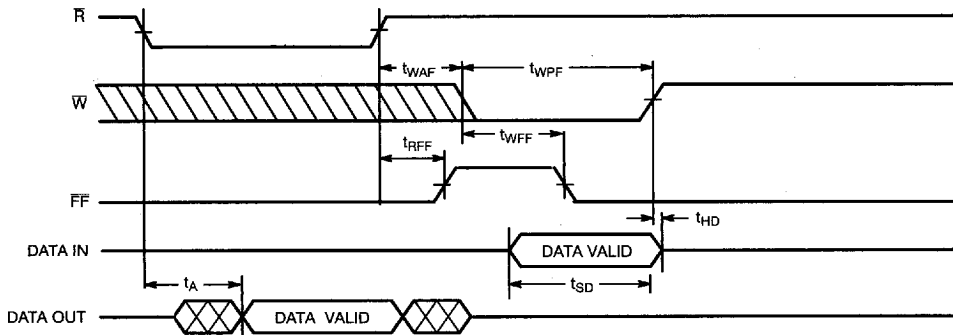
**Full Flag and Write Data Flow-Through Mode**

C460-13

**Notes:**

 10.  $t_{RTC} = t_{PRT} + t_{RTR}$ .

 11. **EF**, **HF** and **FF** may change state during retransmit as a result of the offset of the read and write pointers, but flags will be valid at  $t_{RTC}$ , except for the CY7C46x-20 (Military), whose flags will be valid after  $t_{RTC} + 10$  ns.

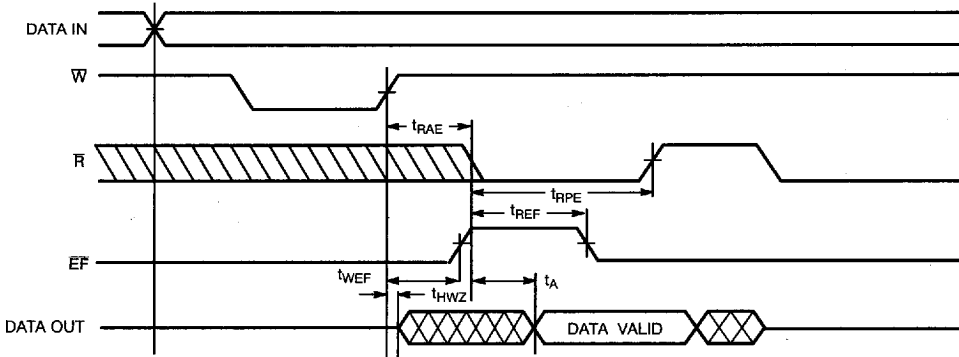
**Switching Waveforms (continued)**
**Empty Flag and Read Data Flow-Through Mode**

C460-14

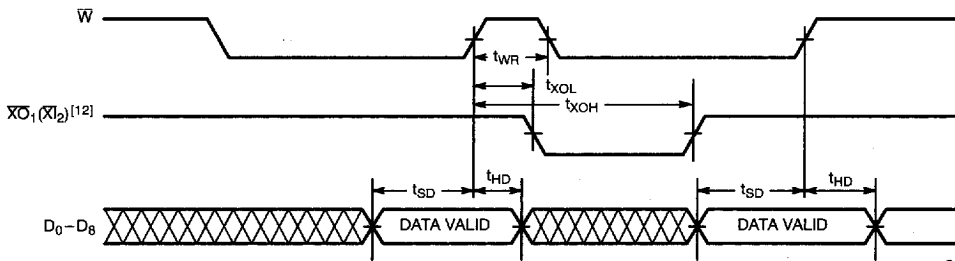
**Expansion Timing Diagrams**

C460-15

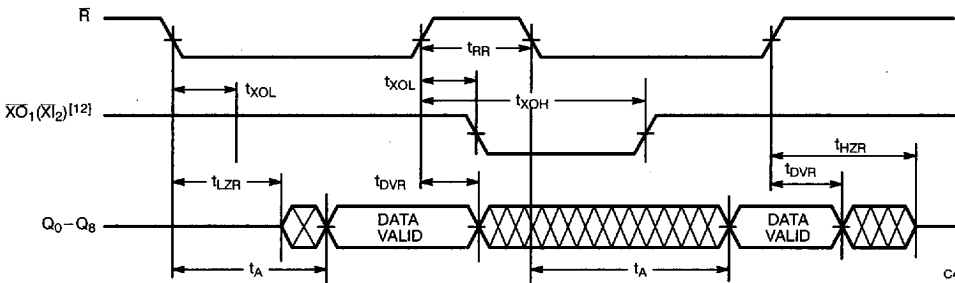

C460-16

**Note:**  
12. Expansion out of device 1 ( $XO_1$ ) is connected to expansion in of device 2 ( $XI_2$ ).

## Architecture

### Resetting the FIFO

Upon power up, the FIFO must be reset with a master reset ( $\overline{MR}$ ) cycle. This causes the FIFO to enter the empty condition signified by the Empty flag ( $\overline{EF}$ ) being LOW, and both the Half Full ( $\overline{HF}$ ), and Full flags ( $\overline{FF}$ ) being HIGH. Read ( $\overline{R}$ ) and write ( $\overline{W}$ ) must be HIGH  $t_{RPW}/t_{WPW}$  before and  $t_{RMR}$  after the rising edge of  $\overline{MR}$  for a valid reset cycle. If reading from the FIFO after a reset cycle is attempted, the outputs will all be in the high-impedance state.

### Writing Data to the FIFO

The availability of at least one empty location is indicated by a HIGH  $\overline{EF}$ . The falling edge of  $\overline{W}$  initiates a write cycle. Data appearing at the inputs ( $D_0 - D_8$ )  $t_{SD}$  before and  $t_{HD}$  after the rising edge of  $\overline{W}$  will be stored sequentially in the FIFO.

The  $\overline{EF}$  LOW-to-HIGH transition occurs  $t_{WEF}$  after the first LOW-to-HIGH transition of  $\overline{W}$  for an empty FIFO.  $\overline{HF}$  goes LOW  $t_{WHF}$  after the falling edge of  $\overline{W}$  following the FIFO actually being half full. Therefore, the  $\overline{HF}$  is active once the FIFO is filled to half its capacity plus one word.  $\overline{HF}$  will remain LOW while less than one half of total memory is available for writing. The LOW-to-HIGH transition of  $\overline{HF}$  occurs  $t_{RHF}$  after the rising edge of  $\overline{R}$  when the FIFO goes from half full + 1 to half full.  $\overline{HF}$  is available in standalone and width expansion modes.  $\overline{FF}$  goes LOW  $t_{WFF}$  after the falling edge of  $\overline{W}$ , during the cycle in which the last available location is filled. Internal logic prevents overrunning a full FIFO. Writes to a full FIFO are ignored and the write pointer is not incremented.  $\overline{FF}$  goes HIGH  $t_{RFF}$  after a read from a full FIFO.

### Reading Data from the FIFO

The falling edge of  $\overline{R}$  initiates a read cycle if the  $\overline{EF}$  is not LOW. Data outputs ( $Q_0 - Q_8$ ) are in a high-impedance condition between read operations ( $\overline{R}$  HIGH), when the FIFO is empty, or when the FIFO is not the active device in the depth expansion mode.

When one word is in the FIFO, the falling edge of  $\overline{R}$  initiates a HIGH-to-LOW transition of  $\overline{EF}$ . When the FIFO is empty, the outputs are in a high-impedance state. Reads to an empty FIFO are ignored and do not increment the read pointer. From the empty condition, the FIFO can be read  $t_{WER}$  after a valid write.

## Retransmit

The retransmit feature is beneficial when transferring packets of data. It enables the receipt of data to be acknowledged by the receiver and retransmitted if necessary. The retransmit ( $\overline{RT}$ ) input is active in the standalone and width expansion modes. The retransmit feature is intended for use when a number of writes equal-to-or-less-than the depth of the FIFO have occurred since the last  $\overline{MR}$  cycle. A LOW pulse on  $\overline{RT}$  resets the internal read pointer to the first physical location of the FIFO.  $\overline{R}$  and  $\overline{W}$  must both be HIGH while and  $t_{TRR}$  after retransmit is LOW. With every read cycle after retransmit, previously accessed data is read and the read pointer incremented until equal to the write pointer. Full, Half Full, and Empty flags are governed by the relative locations of the read and write pointers and are updated during a retransmit cycle. Data written to the FIFO after activation of  $\overline{RT}$  are retransmitted also.

The full depth of the FIFO can be repeatedly retransmitted.

### Standalone/Width Expansion Modes

Standalone and width expansion modes are set by grounding expansion in ( $\overline{XI}$ ) and tying first load ( $\overline{FL}$ ) to  $V_{CC}$  prior to a  $\overline{MR}$  cycle. FIFOs can be expanded in width to provide word widths greater than nine in increments of nine. During width expansion mode, all control line inputs are common to all devices, and flag outputs from any device can be monitored.

### Depth Expansion Mode (see Figure 1)

Depth expansion mode is entered when, during a  $\overline{MR}$  cycle, expansion out ( $\overline{XO}$ ) of one device is connected to expansion in ( $\overline{XI}$ ) of the next device, with  $\overline{XO}$  of the last device connected to  $\overline{XI}$  of the first device. In the depth expansion mode, the first load ( $\overline{FL}$ ) input, when grounded, indicates that this is the first part to be loaded. All other devices must have this pin HIGH. To enable the correct FIFO,  $\overline{XO}$  is pulsed LOW when the last physical location of the previous FIFO is written to and is pulsed LOW again when the last physical location is read. Only one FIFO is enabled for read and one is enabled for write at any given time. All other devices are in standby.

FIFOs can also be expanded simultaneously in depth and width. Consequently, any depth or width FIFO can be created with word widths in increments of nine. When expanding in depth, a composite  $\overline{FF}$  is created by ORing the  $\overline{FF}$ s together. Likewise, a composite  $\overline{EF}$  is created by ORing  $\overline{EF}$ s together.  $\overline{HF}$  and  $\overline{RT}$  functions are not available in depth expansion mode.



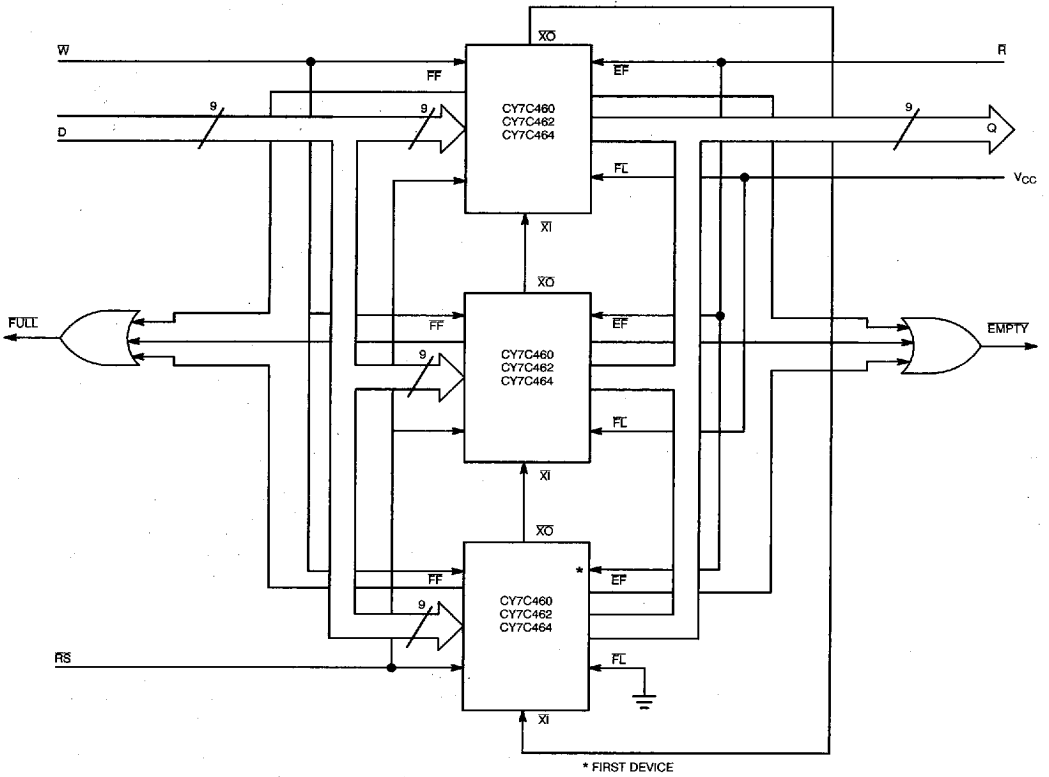
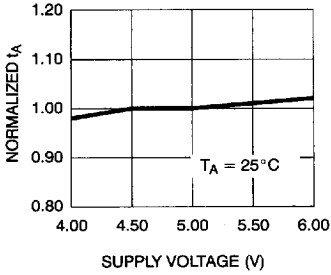
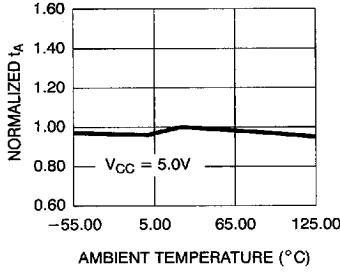
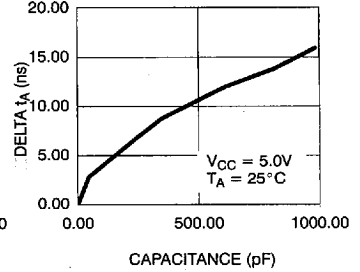
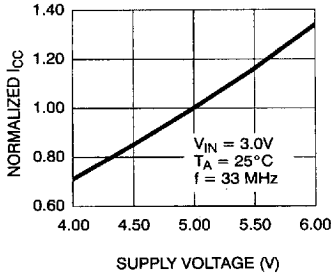
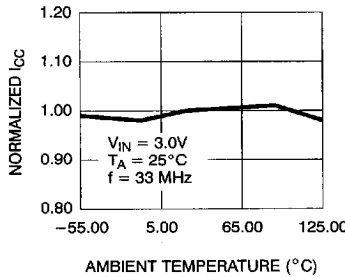
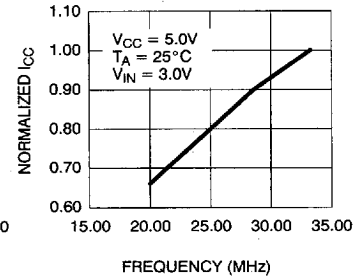
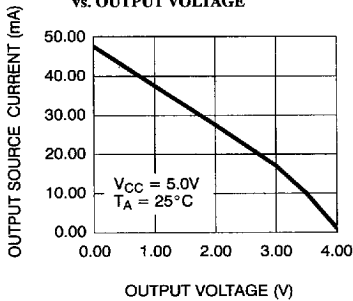
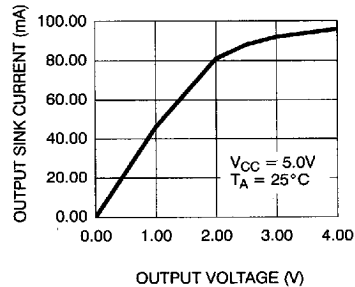

Figure 1. Depth Expansion

C460-17

**Typical AC and DC Characteristics**
**NORMALIZED  $t_A$  vs. SUPPLY VOLTAGE**

**NORMALIZED  $t_A$  vs. AMBIENT TEMPERATURE**

**TYPICAL  $t_A$  CHANGE vs. OUTPUT LOADING**

**NORMALIZED SUPPLY CURRENT vs. SUPPLY VOLTAGE**

**NORMALIZED SUPPLY CURRENT vs. AMBIENT TEMPERATURE**

**NORMALIZED SUPPLY CURRENT vs. FREQUENCY**

**OUTPUT SOURCE CURRENT vs. OUTPUT VOLTAGE**

**OUTPUT SINK CURRENT vs. OUTPUT VOLTAGE**



**Ordering Information**

Speed (ns)	Ordering Code	Package Name	Package Type	Operating Range
15	CY7C460-15JC	J65	32-Lead Plastic Leaded Chip Carrier	Commercial
	CY7C460-15PC	P15	28-Lead (600-Mil) Molded DIP	
	CY7C460-15JI	J65	32-Lead Plastic Leaded Chip Carrier	Industrial
20	CY7C460-20DMB	D43	28-Lead (600-Mil) Sidebrazed CerDIP	Military
	CY7C460-20LMB	L55	32-Pin Rectangular Leadless Chip Carrier	
25	CY7C460-25JC	J65	32-Lead Plastic Leaded Chip Carrier	Commercial
	CY7C460-25PC	P15	28-Lead (600-Mil) Molded DIP	
	CY7C460-25JI	J65	32-Lead Plastic Leaded Chip Carrier	Industrial
	CY7C460-25DMB	D43	28-Lead (600-Mil) Sidebrazed CerDIP	Military
	CY7C460-25LMB	L55	32-Pin Rectangular Leadless Chip Carrier	
40	CY7C460-40JC	J65	32-Lead Plastic Leaded Chip Carrier	Commercial
	CY7C460-40PC	P15	28-Lead (600-Mil) Molded DIP	
	CY7C460-40JI	J65	32-Lead Plastic Leaded Chip Carrier	Industrial
	CY7C460-40DMB	D43	28-Lead (600-Mil) Sidebrazed CerDIP	Military
	CY7C460-40LMB	L55	32-Pin Rectangular Leadless Chip Carrier	
65	CY7C460-65JC	J65	32-Lead Plastic Leaded Chip Carrier	Commercial
	CY7C460-65PC	P15	28-Lead (600-Mil) Molded DIP	
	CY7C460-65JI	J65	32-Lead Plastic Leaded Chip Carrier	Industrial

Speed (ns)	Ordering Code	Package Name	Package Type	Operating Range
15	CY7C462-15JC	J65	32-Lead Plastic Leaded Chip Carrier	Commercial
	CY7C462-15PC	P15	28-Lead (600-Mil) Molded DIP	
	CY7C462-15JI	J65	32-Lead Plastic Leaded Chip Carrier	Industrial
20	CY7C462-20DMB	D43	28-Lead (600-Mil) Sidebrazed CerDIP	Military
	CY7C462-20LMB	L55	32-Pin Rectangular Leadless Chip Carrier	
25	CY7C462-25JC	J65	32-Lead Plastic Leaded Chip Carrier	Commercial
	CY7C462-25PC	P15	28-Lead (600-Mil) Molded DIP	
	CY7C462-25JI	J65	32-Lead Plastic Leaded Chip Carrier	Industrial
	CY7C462-25DMB	D43	28-Lead (600-Mil) Sidebrazed CerDIP	Military
	CY7C462-25LMB	L55	32-Pin Rectangular Leadless Chip Carrier	
40	CY7C462-40JC	J65	32-Lead Plastic Leaded Chip Carrier	Commercial
	CY7C462-40PC	P15	28-Lead (600-Mil) Molded DIP	
	CY7C462-40JI	J65	32-Lead Plastic Leaded Chip Carrier	Industrial
	CY7C462-40DMB	D43	28-Lead (600-Mil) Sidebrazed CerDIP	Military
	CY7C462-40LMB	L55	32-Pin Rectangular Leadless Chip Carrier	
65	CY7C462-65JC	J65	32-Lead Plastic Leaded Chip Carrier	Commercial
	CY7C462-65PC	P15	28-Lead (600-Mil) Molded DIP	
	CY7C462-65JI	J65	32-Lead Plastic Leaded Chip Carrier	Industrial

■ 2589662 0015506 000 ■



Ordering Information (continued)

Speed (ns)	Ordering Code	Package Name	Package Type	Operating Range
15	CY7C464-15JC	J65	32-Lead Plastic Leaded Chip Carrier	Commercial
	CY7C464-15PC	P15	28-Lead (600-Mil) Molded DIP	
	CY7C464-15JI	J65	32-Lead Plastic Leaded Chip Carrier	Industrial
20	CY7C464-20DMB	D43	28-Lead (600-Mil) Sidebrazed CerDIP	Military
	CY7C464-20LMB	L55	32-Pin Rectangular Leadless Chip Carrier	
25	CY7C464-25JC	J65	32-Lead Plastic Leaded Chip Carrier	Commercial
	CY7C464-25PC	P15	28-Lead (600-Mil) Molded DIP	
	CY7C464-25JI	J65	32-Lead Plastic Leaded Chip Carrier	Industrial
	CY7C464-25DMB	D43	28-Lead (600-Mil) Sidebrazed CerDIP	Military
	CY7C464-25LMB	L55	32-Pin Rectangular Leadless Chip Carrier	
40	CY7C464-40JC	J65	32-Lead Plastic Leaded Chip Carrier	Commercial
	CY7C464-40PC	P15	28-Lead (600-Mil) Molded DIP	
	CY7C464-40JI	J65	32-Lead Plastic Leaded Chip Carrier	Industrial
	CY7C464-40DMB	D43	28-Lead (600-Mil) Sidebrazed CerDIP	Military
	CY7C464-40LMB	L55	32-Pin Rectangular Leadless Chip Carrier	
65	CY7C464-65JC	J65	32-Lead Plastic Leaded Chip Carrier	Commercial
	CY7C464-65PC	P15	28-Lead (600-Mil) Molded DIP	
	CY7C464-65JI	J65	32-Lead Plastic Leaded Chip Carrier	Industrial

5

■ 2589662 0015507 T47 ■



**MILITARY SPECIFICATIONS**  
**Group A Subgroup Testing**  
**DC Characteristics**

Parameter	Subgroups
V <sub>OH</sub>	1, 2, 3
V <sub>OL</sub>	1, 2, 3
V <sub>IH</sub>	1, 2, 3
V <sub>IL Max.</sub>	1, 2, 3
I <sub>IX</sub>	1, 2, 3
I <sub>CC</sub>	1, 2, 3
I <sub>SB1</sub>	1, 2, 3
I <sub>SB2</sub>	1, 2, 3
I <sub>OS</sub>	1, 2, 3
I <sub>OZ</sub>	1, 2, 3

**Switching Characteristics**

Parameter	Subgroups
t <sub>RC</sub>	9, 10, 11
t <sub>A</sub>	9, 10, 11
t <sub>RR</sub>	9, 10, 11
t <sub>PR</sub>	9, 10, 11
t <sub>LZR</sub>	9, 10, 11
t <sub>DVR</sub>	9, 10, 11
t <sub>HZR</sub>	9, 10, 11
t <sub>WC</sub>	9, 10, 11
t <sub>PW</sub>	9, 10, 11
t <sub>HWZ</sub>	9, 10, 11
t <sub>WR</sub>	9, 10, 11
t <sub>SD</sub>	9, 10, 11
t <sub>HD</sub>	9, 10, 11
t <sub>MRSC</sub>	9, 10, 11
t <sub>PMR</sub>	9, 10, 11
t <sub>RMR</sub>	9, 10, 11
t <sub>RPW</sub>	9, 10, 11
t <sub>WPW</sub>	9, 10, 11
t <sub>RTC</sub>	9, 10, 11
t <sub>PRT</sub>	9, 10, 11
t <sub>TR</sub>	9, 10, 11
t <sub>EFL</sub>	9, 10, 11
t <sub>HFH</sub>	9, 10, 11
t <sub>FFH</sub>	9, 10, 11
t <sub>REF</sub>	9, 10, 11
t <sub>RFF</sub>	9, 10, 11
t <sub>WEF</sub>	9, 10, 11
t <sub>WFF</sub>	9, 10, 11
t <sub>WHF</sub>	9, 10, 11
t <sub>RHF</sub>	9, 10, 11
t <sub>RAE</sub>	9, 10, 11
t <sub>RPE</sub>	9, 10, 11
t <sub>WAF</sub>	9, 10, 11
t <sub>WPF</sub>	9, 10, 11
t <sub>XOL</sub>	9, 10, 11
t <sub>XOH</sub>	9, 10, 11

Document #: 38-00141-G