

# BIPOLAR ANALOG INTEGRATED CIRCUIT

# $\mu$ PC2918,2925,2926

## THREE-TERMINAL LOW DROPOUT VOLTAGE REGULATOR

### ★ DESCRIPTION

The  $\mu$ PC2918, 2925 and 2926 are three-terminal low dropout voltage regulators with the 1-A output. The  $\mu$ PC2918 outputs 1.8 V, the  $\mu$ PC2925 outputs 2.5 V and the  $\mu$ PC2926 outputs 2.6 V. Since these regulators use a PNP transistor for the output stage, they achieve a low dropout voltage of 0.7 V TYP. at  $I_o = 1$  A and minimize the power dissipation of the IC. As a result, these regulators can be used to realize sets with lower voltage and power dissipation.

### FEATURES

- Output current capacity: 1 A
- Low dropout voltage ( $V_{DIF} = 0.5$  V MAX. (at  $I_o = 0.5$  A))
- Output voltage accuracy:  $\pm 2\%$
- On-chip saturation protector rising edge of input voltage (at low input voltage)
- On-chip overcurrent limiter and thermal protection
- On-chip output transistor safe operation area protection

### PIN CONFIGURATION (Marking Side)

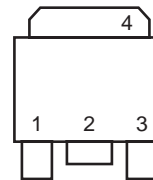

- 1: INPUT
- 2: GND
- 3: OUTPUT
- 4: GND (Fin)

### BLOCK DIAGRAM

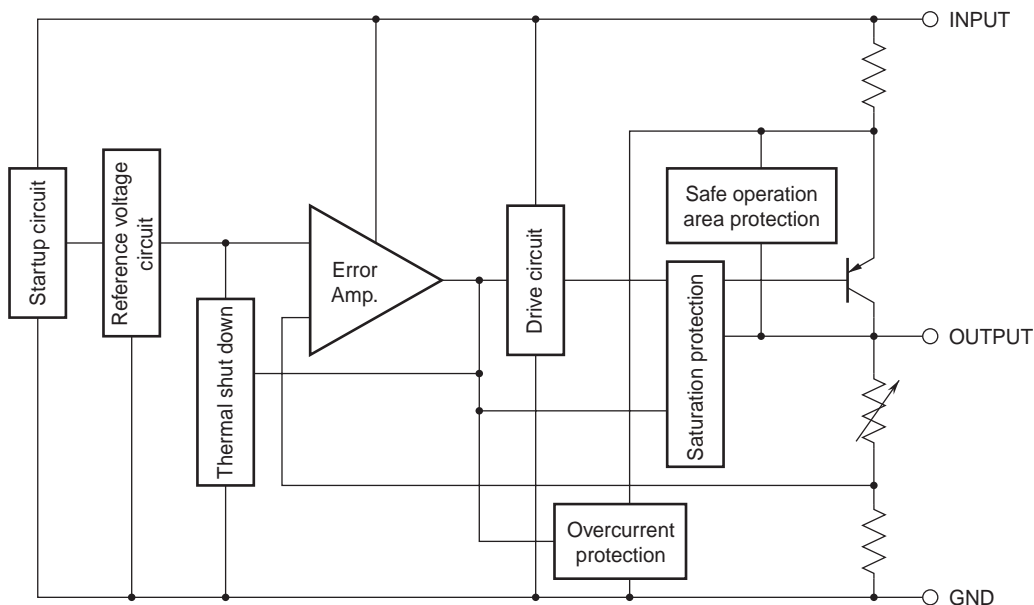

The information in this document is subject to change without notice. Before using this document, please confirm that this is the latest version.  
 Not all devices/types available in every country. Please check with local NEC representative for availability and additional information.

★ ORDERING INFORMATION

Part Number	Package	Marking	Packing Type
μPC29xxT	MP-3Z (SC-63)	29xx	<ul style="list-style-type: none"> <li>• Bag stuffing</li> </ul>
μPC29xxT-E1	MP-3Z (SC-63)	29xx	<ul style="list-style-type: none"> <li>• Embossed-type taping (16mm tape)</li> <li>• Pin 1 on drawout side</li> <li>• 2000 pcs/reel</li> </ul>
μPC29xxT-E2	MP-3Z (SC-63)	29xx	<ul style="list-style-type: none"> <li>• Embossed-type taping (16mm tape)</li> <li>• Pin 1 at takeup side</li> <li>• 2000 pcs/reel</li> </ul>
μPC29xxT-T1	MP-3Z (SC-63)	29xx	<ul style="list-style-type: none"> <li>• Adhesive-type taping (32mm tape)</li> <li>• Pin 1 on drawout side</li> <li>• 1500 pcs/reel</li> </ul>
μPC29xxT-T2	MP-3Z (SC-63)	29xx	<ul style="list-style-type: none"> <li>• Adhesive-type taping (32mm tape)</li> <li>• Pin 1 at takeup side</li> <li>• 1500 pcs/reel</li> </ul>
μPC29xxHB	MP-3 (SC-64)	29xx	<ul style="list-style-type: none"> <li>• Bag stuffing</li> </ul>

"xx" mark of the part number and marking columns expresses output voltage.

Example

Output Voltage	Part Number	Marking
1.8V	μPC2918T	2918
2.5V	μPC2925T	2925
2.6V	μPC2926T	2926

**ABSOLUTE MAXIMUM RATINGS (T<sub>A</sub> = 25°C unless otherwise specified)**

Parameter	Symbol	Rating	Unit
Input Voltage	V <sub>IN</sub>	-0.3 to +20	V
Internal Power Dissipation (T <sub>c</sub> = 25°C)	P <sub>T</sub>	10 <sup>Note</sup>	W
Operating Ambient Temperature	T <sub>A</sub>	-30 to +85	°C
Operating Junction Temperature	T <sub>J</sub>	-30 to +150	°C
Storage Temperature	T <sub>stg</sub>	-55 to +150	°C
Thermal Resistance (junction to case)	R <sub>th(J-C)</sub>	12.5	°C/W
Thermal Resistance (junction to ambient)	R <sub>th(J-A)</sub>	125	°C/W

**Note** Internally limited. When the operating junction temperature rises over 150°C, the internal circuit shuts down the output voltage.

**Caution** If the absolute maximum rating of any of the above parameters is exceeded even momentarily, the quality of the product may be degraded. In other words, absolute maximum ratings specify the values exceeding which the product may be physically damaged. Be sure to use the product with these ratings never exceeded.

★ **TYPICAL CONNECTION**

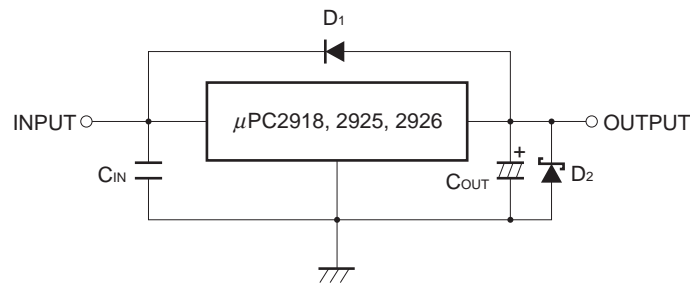

C<sub>IN</sub>: 0.1 μF or higher. Set this value according to the length of the line between the regulator and INPUT pin. Be sure to connect C<sub>IN</sub> to prevent parasitic oscillation. Use of a film capacitor or other capacitor with excellent voltage and temperature characteristics is recommended. If using a laminated ceramic capacitor, it is necessary to ensure that C<sub>IN</sub> is 0.1 μF or higher for the voltage and temperature range to be used.

C<sub>OUT</sub>: 10 μF or higher. Be sure to connect C<sub>OUT</sub> to prevent oscillation and improve excessive load regulation. Place C<sub>IN</sub> and C<sub>OUT</sub> as close as possible to the IC pins (within 2 cm). Also, use an electrolytic capacitor with low impedance characteristics if considering use at sub-zero temperatures.

D<sub>1</sub>: If the OUTPUT pin has a higher voltage than the INPUT pin, connect a diode.

D<sub>2</sub>: If the OUTPUT pin has a lower voltage than the GND pin, connect a Schottky barrier diode.

**Caution** Make sure that no voltage is applied to the OUTPUT pin from external.

**RECOMMENDED OPERATING CONDITIONS**

Parameter	Symbol	Type Number	MIN.	TYP.	MAX.	Unit
Input Voltage	V <sub>IN</sub>	μPC2918	2.8		16	V
		μPC2925	3.5		16	V
		μPC2926	3.6		16	V
Output Current	I <sub>o</sub>	All	0		1	A
Operating Ambient Temperature	T <sub>A</sub>	All	-30		+85	°C
Operating Junction Temperature	T <sub>J</sub>	All	-30		+125	°C

★

**Caution** Use of conditions other than the above-listed recommended operating conditions is not a problem as long as the absolute maximum ratings are not exceeded. However, since the use of such conditions diminishes the margin of safety, careful evaluation is required before such conditions are used. Moreover, using the MAX. value for all the recommended operating conditions is not guaranteed to be safe.

**ELECTRICAL CHARACTERISTICS**

μPC2918 (T<sub>J</sub> = 25°C, V<sub>IN</sub> = 2.8 V, I<sub>o</sub> = 0.5 A, C<sub>IN</sub> = 0.1 μF, C<sub>OUT</sub> = 10 μF, unless otherwise specified)

Parameter	Symbol	Conditions	MIN.	TYP.	MAX.	Unit
Output Voltage	V <sub>o</sub>		1.764	1.8	1.836	V
		2.8 V ≤ V <sub>IN</sub> ≤ 5 V, 0 A ≤ I <sub>o</sub> ≤ 1 A, 0°C ≤ T <sub>J</sub> ≤ 125°C	(1.71)		(1.854)	V
Line Regulation	REG <sub>IN</sub>	2.8 V ≤ V <sub>IN</sub> ≤ 16 V		6	25	mV
Load Regulation	REG <sub>L</sub>	0 A ≤ I <sub>o</sub> ≤ 1 A		7	30	mV
Quiescent Current	I <sub>BIAS</sub>	I <sub>o</sub> = 0 A		2	4	mA
		I <sub>o</sub> = 1 A		20	60	mA
Startup Quiescent Current	I <sub>BIAS (s)</sub>	V <sub>IN</sub> = 2.4 V, I <sub>o</sub> = 0 A		10	30	mA
		V <sub>IN</sub> = 2.4 V, I <sub>o</sub> = 1 A			80	mA
Quiescent Current Change	ΔI <sub>BIAS</sub>	2.8 V ≤ V <sub>IN</sub> ≤ 16 V, 0°C ≤ T <sub>J</sub> ≤ 125°C		2.9	20	mA
Output Noise Voltage	V <sub>n</sub>	10 Hz ≤ f ≤ 100 kHz		40		μV <sub>r.m.s.</sub>
Ripple Rejection	R•R	f = 120 Hz, 2.8 V ≤ V <sub>IN</sub> ≤ 9 V	45	60		dB
Dropout Voltage	V <sub>DIF</sub>	I <sub>o</sub> = 0.5 A		0.25	0.5	V
		I <sub>o</sub> = 1 A, 0°C ≤ T <sub>J</sub> ≤ 125°C		0.7		V
Short Circuit Current	I <sub>o short</sub>	V <sub>IN</sub> = 2.8 V	1.2	1.7	3.0	A
		V <sub>IN</sub> = 16 V		1.2		A
Peak Output Current	I <sub>o peak</sub>	V <sub>IN</sub> = 2.8 V	1.0	1.5	3.0	A
		V <sub>IN</sub> = 16 V		1.1		A
Temperature Coefficient of Output Voltage	ΔV <sub>o</sub> / ΔT	I <sub>o</sub> = 5 mA, 0°C ≤ T <sub>J</sub> ≤ 125°C		-0.4		mV/°C

**Remark** Values in parentheses have been measured during product design and are provided as reference values.

μPC2925 (T<sub>J</sub> = 25°C, V<sub>IN</sub> = 3.5 V, I<sub>o</sub> = 0.5 A, C<sub>IN</sub> = 0.1 μF, C<sub>OUT</sub> = 10 μF, unless otherwise specified)

Parameter	Symbol	Conditions	MIN.	TYP.	MAX.	Unit
Output Voltage	V <sub>O</sub>		2.45	2.5	2.55	V
		3.5 V ≤ V <sub>IN</sub> ≤ 5 V, 0 A ≤ I <sub>o</sub> ≤ 1 A, 0°C ≤ T <sub>J</sub> ≤ 125°C	(2.375)		(2.575)	V
Line Regulation	REG <sub>IN</sub>	3.5 V ≤ V <sub>IN</sub> ≤ 16 V		6	25	mV
Load Regulation	REG <sub>L</sub>	0 A ≤ I <sub>o</sub> ≤ 1 A		7	30	mV
Quiescent Current	I <sub>BIAS</sub>	I <sub>o</sub> = 0 A		2	4	mA
		I <sub>o</sub> = 1 A		20	60	mA
Startup Quiescent Current	I <sub>BIAS (s)</sub>	V <sub>IN</sub> = 2.4 V, I <sub>o</sub> = 0 A		10	30	mA
		V <sub>IN</sub> = 3.0 V, I <sub>o</sub> = 1 A			80	mA
Quiescent Current Change	ΔI <sub>BIAS</sub>	3.5 V ≤ V <sub>IN</sub> ≤ 16 V, 0°C ≤ T <sub>J</sub> ≤ 125°C		2.9	20	mA
Output Noise Voltage	V <sub>n</sub>	10 Hz ≤ f ≤ 100 kHz		40		μV <sub>r.m.s.</sub>
Ripple Rejection	R•R	f = 120 Hz, 3.5 V ≤ V <sub>IN</sub> ≤ 9 V	45	60		dB
Dropout Voltage	V <sub>DIF</sub>	I <sub>o</sub> = 0.5 A		0.25	0.5	V
		I <sub>o</sub> = 1 A, 0°C ≤ T <sub>J</sub> ≤ 125°C		0.7		V
Short Circuit Current	I <sub>short</sub>	V <sub>IN</sub> = 3.5 V	1.2	1.7	3.0	A
		V <sub>IN</sub> = 16 V		1.2		A
Peak Output Current	I <sub>opeak</sub>	V <sub>IN</sub> = 3.5 V	1.0	1.5	3.0	A
		V <sub>IN</sub> = 16 V		1.1		A
Temperature Coefficient of Output Voltage	ΔV <sub>O</sub> / ΔT	I <sub>o</sub> = 5 mA, 0°C ≤ T <sub>J</sub> ≤ 125°C		-0.5		mV/°C

**Remark** Values in parentheses have been measured during product design and are provided as reference values.

★ μPC2926 (T<sub>J</sub> = 25°C, V<sub>IN</sub> = 3.6 V, I<sub>o</sub> = 0.5 A, C<sub>IN</sub> = 0.1 μF, C<sub>OUT</sub> = 10 μF, unless otherwise specified)

Parameter	Symbol	Conditions	MIN.	TYP.	MAX.	Unit
Output Voltage	V <sub>O</sub>		2.548	2.6	2.652	V
		3.6 V ≤ V <sub>IN</sub> ≤ 5 V, 0 A ≤ I <sub>o</sub> ≤ 1 A, 0°C ≤ T <sub>J</sub> ≤ 125°C	(2.470)		(2.678)	V
Line Regulation	REG <sub>IN</sub>	3.6 V ≤ V <sub>IN</sub> ≤ 16 V		6	25	mV
Load Regulation	REG <sub>L</sub>	0 A ≤ I <sub>o</sub> ≤ 1 A		7	30	mV
Quiescent Current	I <sub>BIAS</sub>	I <sub>o</sub> = 0 A		2	4	mA
		I <sub>o</sub> = 1 A		20	60	mA
Startup Quiescent Current	I <sub>BIAS (s)</sub>	V <sub>IN</sub> = 2.4 V, I <sub>o</sub> = 0 A		10	30	mA
		V <sub>IN</sub> = 3.0 V, I <sub>o</sub> = 1 A			80	mA
Quiescent Current Change	ΔI <sub>BIAS</sub>	3.6 V ≤ V <sub>IN</sub> ≤ 16 V, 0°C ≤ T <sub>J</sub> ≤ 125°C		2.9	20	mA
Output Noise Voltage	V <sub>n</sub>	10 Hz ≤ f ≤ 100 kHz		40		μV <sub>r.m.s.</sub>
Ripple Rejection	R•R	f = 120 Hz, 3.6 V ≤ V <sub>IN</sub> ≤ 9 V	45	60		dB
Dropout Voltage	V <sub>DIF</sub>	I <sub>o</sub> = 0.5 A		0.25	0.5	V
		I <sub>o</sub> = 1 A, 0°C ≤ T <sub>J</sub> ≤ 125°C		0.7		V
Short Circuit Current	I <sub>short</sub>	V <sub>IN</sub> = 3.6 V	1.2	1.7	3.0	A
		V <sub>IN</sub> = 16 V		1.2		A
Peak Output Current	I <sub>opeak</sub>	V <sub>IN</sub> = 3.6 V	1.0	1.5	3.0	A
		V <sub>IN</sub> = 16 V		1.1		A
Temperature Coefficient of Output Voltage	ΔV <sub>O</sub> / ΔT	I <sub>o</sub> = 5 mA, 0°C ≤ T <sub>J</sub> ≤ 125°C		-0.5		mV/°C

**Remark** Values in parentheses have been measured during product design and are provided as reference values.

TYPICAL CHARACTERISTICS (Reference Values)

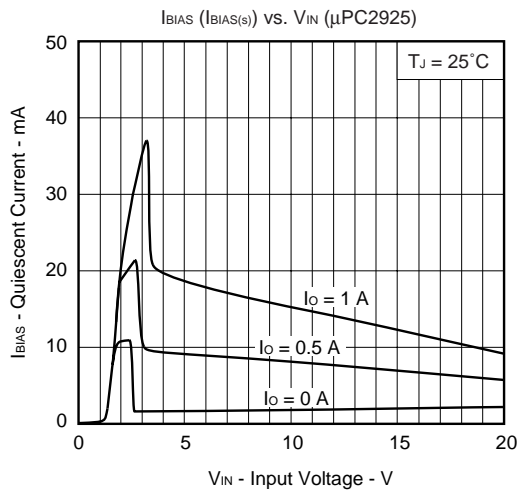
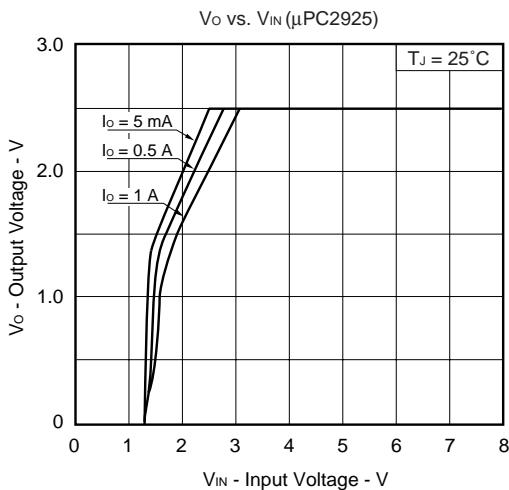
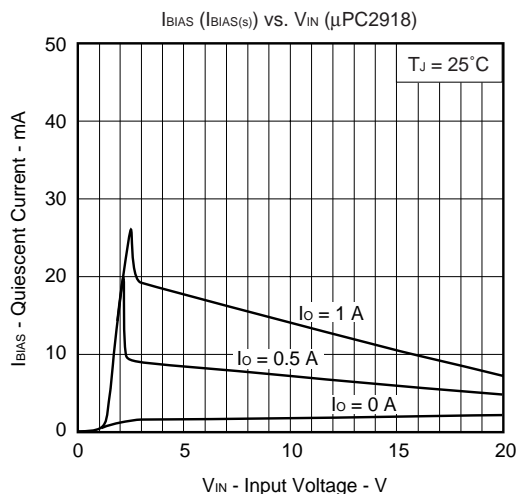
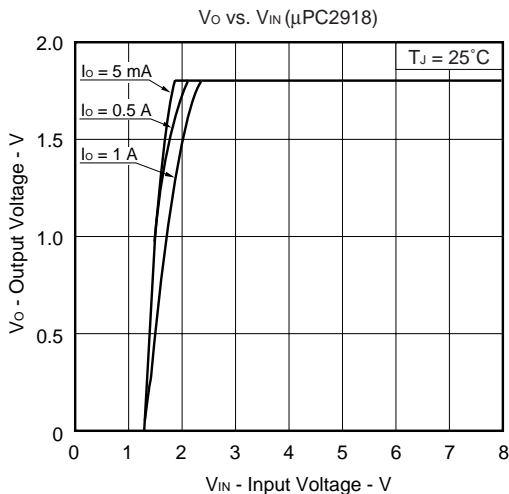
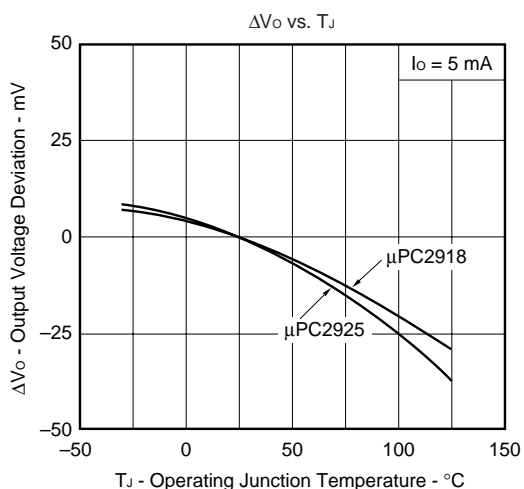
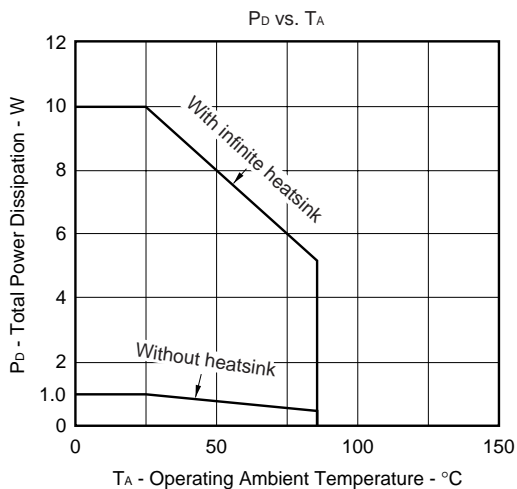

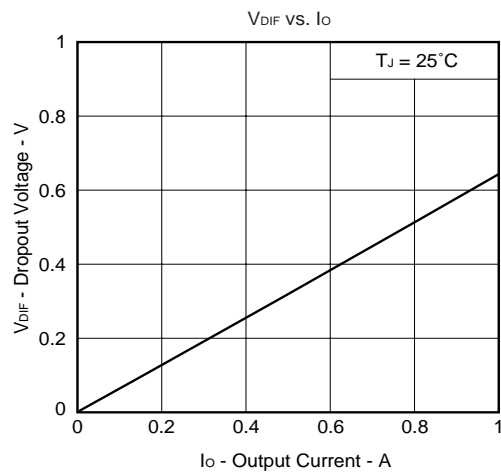
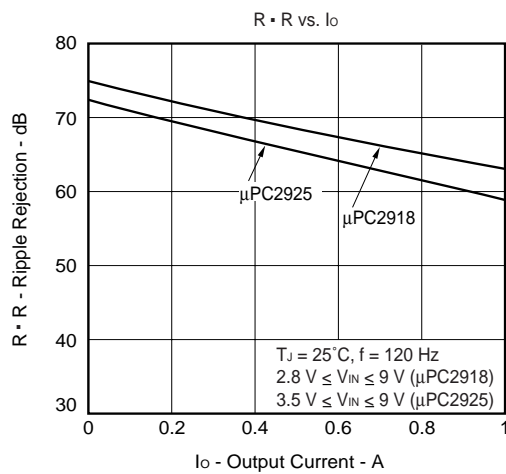
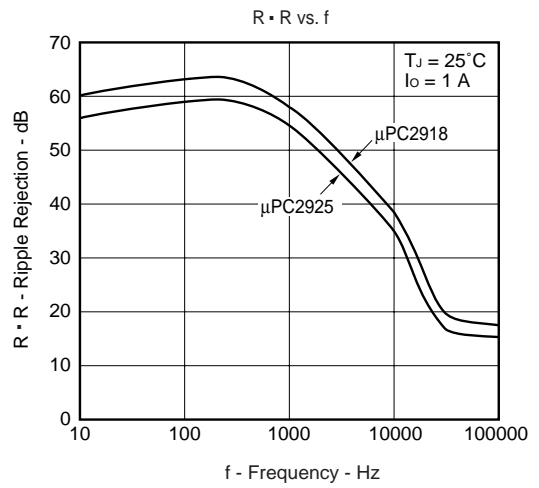
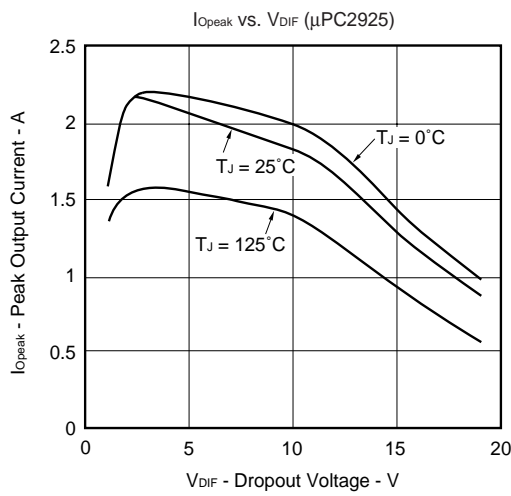
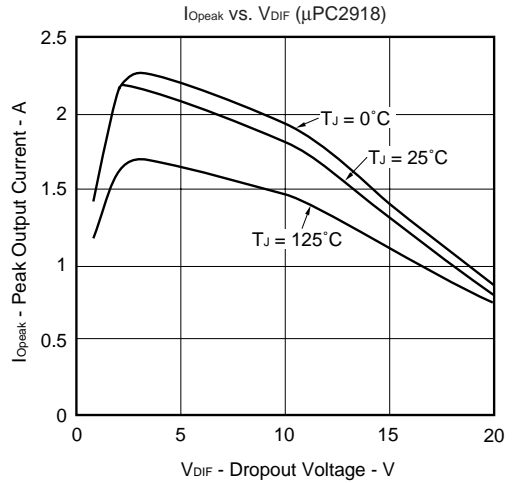
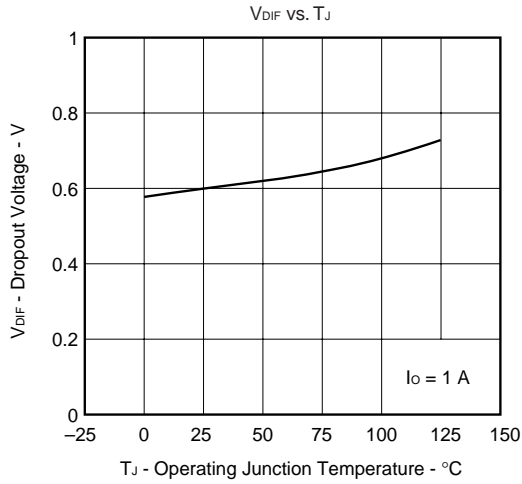

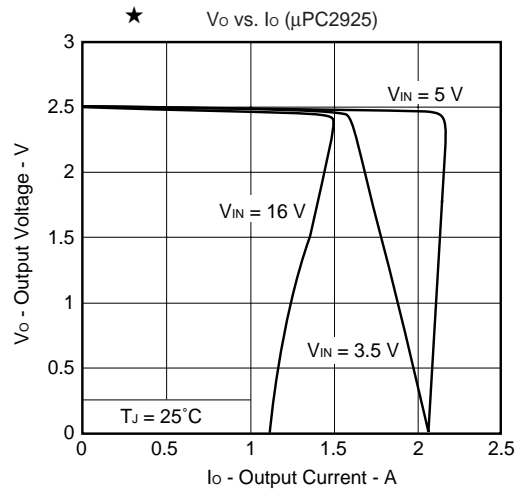
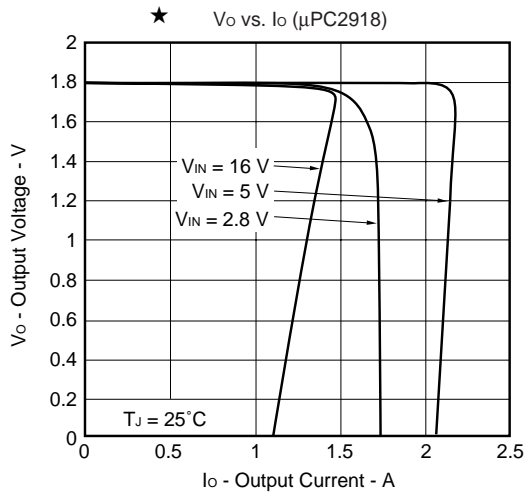



PACKAGE DRAWINGS

MP-3Z (SC-63) (Unit: mm)

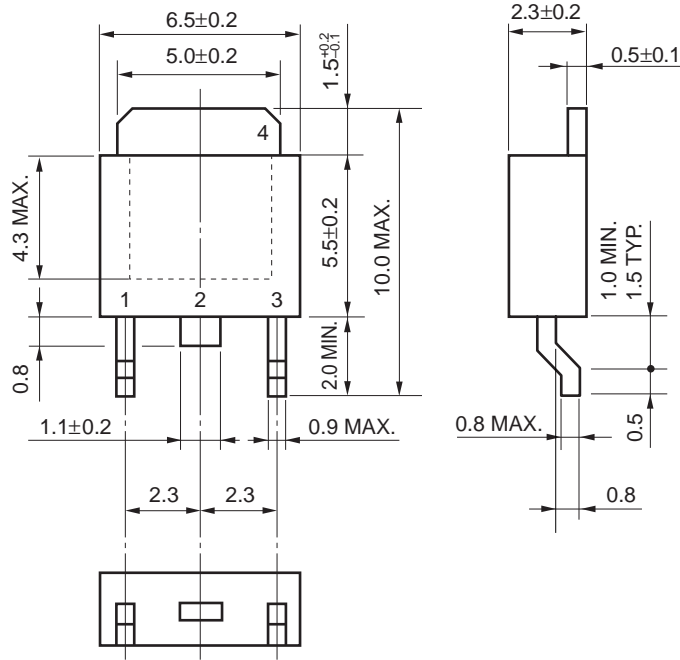

★ MP-3 (SC-64) (Unit: mm)

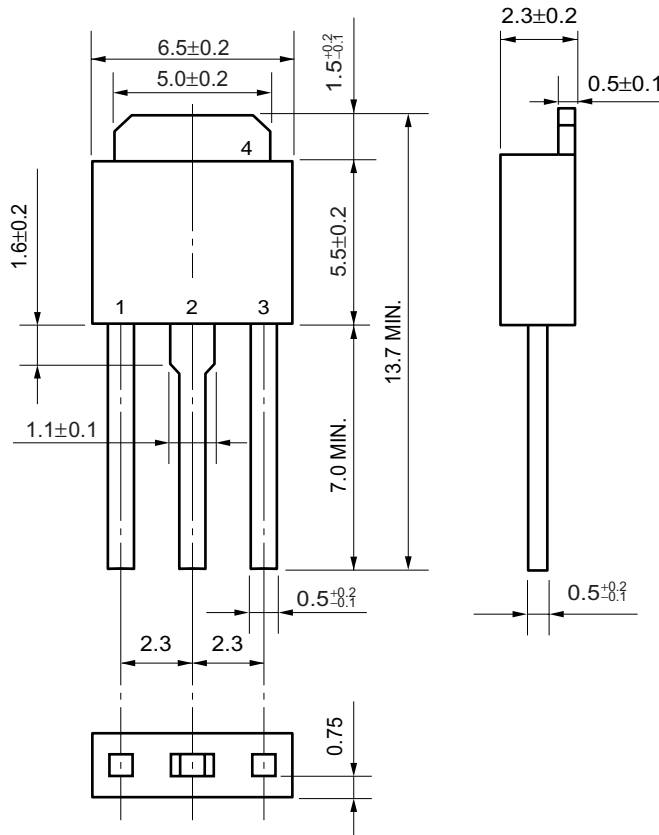

★ RECOMMENDED SOLDERING CONDITIONS

The μPC2918, 2925 and 2926 should be soldered and mounted under the following recommended conditions.

For the details of the recommended soldering conditions, refer to the document **Semiconductor Device Mounting Technology Manual (C10535E)**.

For soldering methods and conditions other than those recommended below, contact our sales representative.

Type of Surface Mount Device

μPC2918T, μPC2925T, μPC2926T: MP-3Z(SC-63)

Process	Conditions	Symbol
Infrared Ray Reflow	Peak temperature: 235°C or below (Package surface temperature), Reflow time: 30 seconds or less (at 210°C or higher), Maximum number of reflow processes: 3 times or less.	IR35-00-3
Vapor Phase Soldering	Peak temperature: 215°C or below (Package surface temperature), Reflow time: 40 seconds or less (at 200°C or higher), Maximum number of reflow processes: 3 times or less.	VP15-00-3
Wave Soldering	Solder temperature: 260°C or below, Flow time: 10 seconds or less, Maximum number of flow processes: 1 time, Pre-heating temperature: 120°C or below (Package surface temperature).	WS60-00-1
Partial Heating Method	Pin temperature: 300°C or below, Heat time: 3 seconds or less (Per each side of the device).	—

**Caution** Apply only one kind of soldering condition to a device, except for "partial heating method", or the device will be damaged by heat stress.

Type of Through-hole Device

μPC2918HB, μPC2925HB, μPC2926HB: MP-3(SC-64)

Process	Conditions
Wave Soldering (only to leads)	Solder temperature: 260°C or below, Flow time: 10 seconds or less
Partial Heating Method	Pin temperature: 300°C or below, Heat time: 3 seconds or less (Per each pin).

**Caution** For through-hole device, the wave soldering process must be applied only to leads, and make sure that the package body does not get jet soldered.

**NOTES ON USE**

When the  $\mu$ PC2918, 2925, and 2926 are used with an input voltage that is lower than the value indicated in the recommended operating conditions, a large quiescent current flows through the device due to saturation of the transistor of the output stage. (Refer to the  $I_{BIAS}$  ( $I_{BIAS(S)}$ ) vs.  $V_{IN}$  curves in TYPICAL CHARACTERISTICS).

These products have saturation protector, but a current of up to 80 mA MAX. may flow through the device. Thus the power supply on the input side must have sufficient capacity to allow this quiescent current to pass when the device starts up.

**REFERENCE DOCUMENTS**

Document Name	Document No.
Usage of Three-Terminal Regulators User's Manual	G12702E
Voltage Regulator of SMD Information	G11872E
Semiconductor Device Mounting Technology Manual Information	C10535E
SEMICONDUCTOR SELECTION GUIDE - Products and Packages-	X13769X

- **The information in this document is current as of May, 2001. The information is subject to change without notice. For actual design-in, refer to the latest publications of NEC's data sheets or data books, etc., for the most up-to-date specifications of NEC semiconductor products. Not all products and/or types are available in every country. Please check with an NEC sales representative for availability and additional information.**
  - No part of this document may be copied or reproduced in any form or by any means without prior written consent of NEC. NEC assumes no responsibility for any errors that may appear in this document.
  - NEC does not assume any liability for infringement of patents, copyrights or other intellectual property rights of third parties by or arising from the use of NEC semiconductor products listed in this document or any other liability arising from the use of such products. No license, express, implied or otherwise, is granted under any patents, copyrights or other intellectual property rights of NEC or others.
  - Descriptions of circuits, software and other related information in this document are provided for illustrative purposes in semiconductor product operation and application examples. The incorporation of these circuits, software and information in the design of customer's equipment shall be done under the full responsibility of customer. NEC assumes no responsibility for any losses incurred by customers or third parties arising from the use of these circuits, software and information.
  - While NEC endeavours to enhance the quality, reliability and safety of NEC semiconductor products, customers agree and acknowledge that the possibility of defects thereof cannot be eliminated entirely. To minimize risks of damage to property or injury (including death) to persons arising from defects in NEC semiconductor products, customers must incorporate sufficient safety measures in their design, such as redundancy, fire-containment, and anti-failure features.
  - NEC semiconductor products are classified into the following three quality grades:  
 "Standard", "Special" and "Specific". The "Specific" quality grade applies only to semiconductor products developed based on a customer-designated "quality assurance program" for a specific application. The recommended applications of a semiconductor product depend on its quality grade, as indicated below. Customers must check the quality grade of each semiconductor product before using it in a particular application.  
 "Standard": Computers, office equipment, communications equipment, test and measurement equipment, audio and visual equipment, home electronic appliances, machine tools, personal electronic equipment and industrial robots  
 "Special": Transportation equipment (automobiles, trains, ships, etc.), traffic control systems, anti-disaster systems, anti-crime systems, safety equipment and medical equipment (not specifically designed for life support)  
 "Specific": Aircraft, aerospace equipment, submersible repeaters, nuclear reactor control systems, life support systems and medical equipment for life support, etc.
- The quality grade of NEC semiconductor products is "Standard" unless otherwise expressly specified in NEC's data sheets or data books, etc. If customers wish to use NEC semiconductor products in applications not intended by NEC, they must contact an NEC sales representative in advance to determine NEC's willingness to support a given application.
- (Note)
- (1) "NEC" as used in this statement means NEC Corporation and also includes its majority-owned subsidiaries.
  - (2) "NEC semiconductor products" means any semiconductor product developed or manufactured by or for NEC (as defined above).