

VOLTAGE REGULATOR WITH ON/OFF SWITCH

FEATURES

- Low Dropout Voltage
- Electronic ON/OFF Switch
- Very Low Standby Current (ON, No Load)
- Internal Thermal Shutdown
- Short Circuit Protection
- Very Low (<100 nA) Current in OFF Mode
- Customized Versions Are Available

DESCRIPTION

The TK114xx is a low power, linear regulator with a built-in electronic switch. The internal electronic switch can be controlled by an external pull-up resistor and an open drain or open collector transistor. The device is in the OFF state when the control pin is biased from V_{IN} through the pull-up resistor.

An internal PNP pass-transistor is used in order to achieve low dropout voltage (typically 200 mV at 50 mA load current). The device has very low quiescent current (500 μ A) in the ON mode with no load and 2 mA with 30 mA load. The quiescent current is typically 4 mA at 60 mA load. An internal thermal shutdown circuit limits the junction temperature to below 150 °C. The load current is internally monitored and the device will shut down (no load current) in the presence of a short circuit at the output. The device is available in a small SOT-23L surface mount package.

APPLICATIONS

- Battery Powered Systems
- Cellular Telephones
- Pagers
- Personal Communications Equipment
- Portable Instrumentation
- Portable Consumer Equipment
- Radio Control Systems
- Toys
- Low Voltage Systems

ORDERING INFORMATION

TK114 □□ □□

└─ Tape/Reel Code

└─ Voltage Code

VOLTAGE CODE	
30 = 3.0 V	47 = 4.75 V
32 = 3.25 V	50 = 5.0 V
35 = 3.5 V	55 = 5.5 V
37 = 3.75 V	57 = 5.75 V
40 = 4.0 V	60 = 6.0 V
45 = 4.5 V	80 = 8.0 V

TAPE/REEL CODE
 BX : Bulk/Bag
 TL : Tape Left

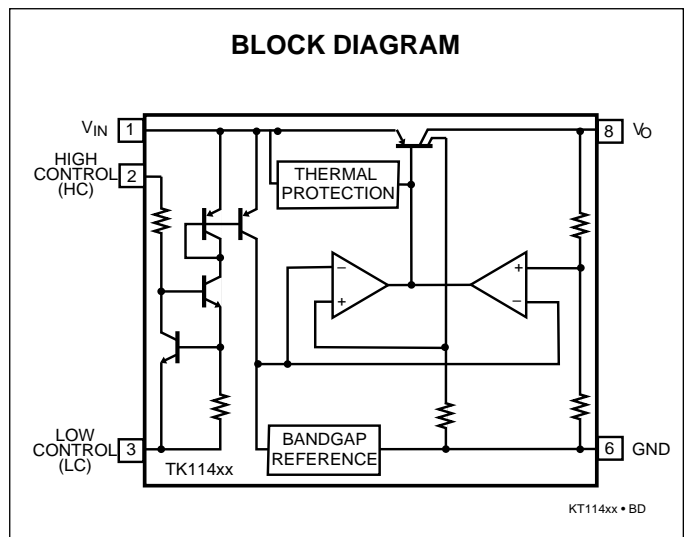
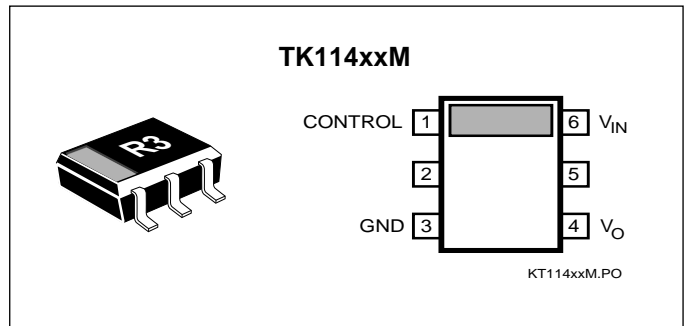

TK114xx

ABSOLUTE MAXIMUM RATINGS

Supply Voltage	16 V	Operating Temperature Range	-30 to +80 °C
Load Current	180 mA	Lead Soldering Temp. (10 sec.)	240 °C
Power Dissipation (Note 1)	400 mW	Junction Temperature	150 °C
Storage Temperature Range	-55 to +150 °C		

TK11430 ELECTRICAL CHARACTERISTICS

SYMBOL	PARAMETER	TEST CONDITION	MIN	TYP	MAX	UNITS
I_{IN1}	Supply Current 1	$V_{IN} = 4\text{ V}, I_O = 0\text{ mA}$		500	900	μA
I_{IN2}	Supply Current 2	$V_{IN} = 2.5\text{ V}, I_O = 0\text{ mA}$		1	2.5	μA
I_{INS}	Standby Current	$V_{IN} = 10\text{ V}, \text{Output Off}$			0.1	μA
V_O	Output Voltage Regulation	$V_{IN} = 4\text{ V}, I_O = 30\text{ mA}$	2.9	3.0	3.1	%
V_{DROPO}	Dropout Voltage	$I_O = 30\text{ mA}$		0.12	0.3	V
I_O	Output Current		70	110		mA
I_{OR}	Recommended Output Current				70	mA
LinReg	Line Regulation	$V_{IN} = 4\text{ V} \rightarrow 9\text{ V}$		5	30	mV
LoaReg	Load Regulation	$I_O = 0\text{ mA to } 30\text{ mA}$		18	50	mV
		$I_O = 0\text{ mA to } 60\text{ mA}$		36	80	mV
RR	Ripple Rejection	100 mV(rms), $f = 400\text{ Hz}$ $V_{IN} = 4.5\text{ V}, I_O = 10\text{ mA}$		55		dB
$\Delta V/\Delta T$	V_O Temperature Coefficient	$V_{IN} = 4.5\text{ V}, I_O = 10\text{ mA}$ $-20\text{ }^\circ\text{C} \leq T_A \leq 75\text{ }^\circ\text{C}$		± 0.3		mV/°C
V_N	Output Noise Voltage	$V_{IN} = 4.5\text{ V}, I_O = 10\text{ mA}$		180		$\mu\text{V(rms)}$
Control Pin						
I_{CONT}	Control Pin Current	On Mode		35	120	μA
V_{Coff}	Control Pin Voltage	Off Mode	$V_{IN}-0.2$		V_{IN}	V
V_{Con}	Control Pin Voltage	On Mode	0		0.6	V

Note 1: Power dissipation must be derated at the rate of 1.6 mW/ °C for operation above $T_A = 25\text{ }^\circ\text{C}$.

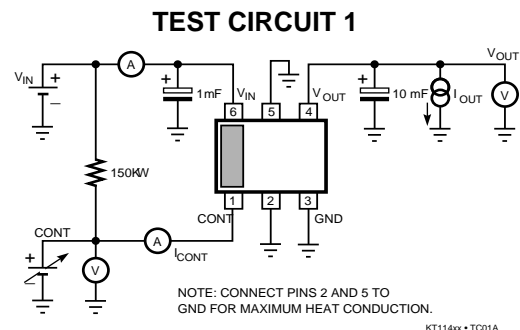

TK11432 ELECTRICAL CHARACTERISTICS

SYMBOL	PARAMETER	TEST CONDITION	MIN	TYP	MAX	UNITS
I_{IN1}	Supply Current 1	$V_{IN} = 4.2 \text{ V}, I_O = 0 \text{ mA}$		500	900	μA
I_{IN2}	Supply Current 2	$V_{IN} = 2.5 \text{ V}, I_O = 0 \text{ mA}$		1	2.5	μA
I_{INS}	Standby Current	$V_{IN} = 10 \text{ V}, \text{Output Off}$			0.1	μA
V_O	Output Voltage Regulation	$V_{IN} = 4.2 \text{ V}, I_O = 30 \text{ mA}$	3.13	3.25	3.37	%
V_{DROP}	Dropout Voltage	$I_O = 30 \text{ mA}$		0.12	0.3	V
I_O	Output Current	(Note 2)	70	110		mA
I_{OR}	Recommended Output Current				70	mA
LinReg	Line Regulation	$V_{IN} = 4.2 \text{ V} \rightarrow 9.2 \text{ V}$		6	30	mV
LoaReg	Load Regulation	$V_{IN} = 4.2 \text{ V}, I_O = 0 \text{ mA to } 30 \text{ mA}$		20	50	mV
		$V_{IN} = 4.2 \text{ V}, I_O = 0 \text{ mA to } 60 \text{ mA}$		40	80	mV
RR	Ripple Rejection	100 mV(rms), $f = 400 \text{ Hz}$ $V_{IN} = 4.7 \text{ V}, I_O = 10 \text{ mA}$		55		dB
$\Delta V/\Delta T$	V_O Temperature Coefficient	$V_{IN} = 4.7 \text{ V}, I_O = 10 \text{ mA}$ $-20 \text{ }^\circ\text{C} \leq T_A \leq 75 \text{ }^\circ\text{C}$		± 0.3		mV/ $^\circ\text{C}$
V_N	Output Noise Voltage	$10 \text{ Hz} \leq f \leq 100 \text{ KHz}, I_O = 10 \text{ mA}$		180		$\mu\text{V(rms)}$
Control Pin						
I_{CONT}	Control Pin Current	On Mode		35	120	μA
V_{Coff}	Control Pin Voltage	Off Mode	$V_{IN}-0.2$		V_{IN}	V
V_{Con}	Control Pin Voltage	On Mode	0		0.6	V

Note 2: I_O (Load Current) is current when V_O drop down 0.3V from V_O at $I_O = 30 \text{ mA}$.

TK11435 ELECTRICAL CHARACTERISTICS

SYMBOL	PARAMETER	TEST CONDITION	MIN	TYP	MAX	UNITS
I_{IN1}	Supply Current 1	$V_{IN} = 4.5\text{ V}, I_O = 0\text{ mA}$		500	900	μA
I_{IN2}	Supply Current 2	$V_{IN} = 2.5\text{ V}, I_O = 0\text{ mA}$		1	2.5	μA
I_{INS}	Standby Current	$V_{IN} = 10\text{ V}, \text{Output Off}$			0.1	μA
V_O	Output Voltage Regulation	$V_{IN} = 4.5\text{ V}, I_O = 30\text{ mA}$	3.38	3.5	3.62	%
V_{DROP}	Dropout Voltage	$I_O = 30\text{ mA}$		0.12	0.3	V
I_O	Output Current	(Note 2)	70	110		mA
I_{OR}	Recommended Output Current				70	mA
LinReg	Line Regulation	$V_{IN} = 4.5\text{ V} \rightarrow 9.5\text{ V}$		7	35	mV
LoaReg	Load Regulation	$I_O = 0\text{ mA to }30\text{ mA}$		20	55	mV
		$I_O = 0\text{ mA to }60\text{ mA}$		40	95	mV
RR	Ripple Rejection	100 mV(rms), $f = 400\text{ Hz}$ $V_{IN} = 4.5\text{ V}, I_O = 10\text{ mA}$		55		dB
$\Delta V/\Delta T$	V_O Temperature Coefficient	$V_{IN} = 4.5\text{ V}, I_O = 10\text{ mA}$ $-20\text{ }^\circ\text{C} \leq T_A \leq 75\text{ }^\circ\text{C}$		± 0.3		mV/ $^\circ\text{C}$
V_N	Output Noise Voltage	$V_{IN} = 4.5\text{ V}, I_O = 10\text{ mA}$		180		$\mu\text{V(rms)}$
Control Pin						
I_{CONT}	Control Pin Current	On Mode		35	120	μA
V_{Coff}	Control Pin Voltage	Off Mode	$V_{IN}-0.2$		V_{IN}	V
V_{Con}	Control Pin Voltage	On Mode	0		0.6	V

Note 2: I_O (Load Current) is current when V_O drop down 0.3V from V_O at $I_O = 30\text{ mA}$.

TK11437 ELECTRICAL CHARACTERISTICS

SYMBOL	PARAMETER	TEST CONDITION	MIN	TYP	MAX	UNITS
I_{IN1}	Supply Current 1	$V_{IN} = 4.7 \text{ V}, I_O = 0 \text{ mA}$		500	900	μA
I_{IN2}	Supply Current 2	$V_{IN} = 2.7 \text{ V}, I_O = 0 \text{ mA}$		1	2.5	μA
I_{INS}	Standby Current	$V_{IN} = 10 \text{ V}, \text{Output Off}$			0.1	μA
V_O	Output Voltage Regulation	$V_{IN} = 4.7 \text{ V}, I_O = 30 \text{ mA}$	3.62	3.75	3.88	%
V_{DROP}	Dropout Voltage	$I_O = 30 \text{ mA}$		0.12	0.3	V
I_O	Output Current	(Note 2)	70	110		mA
I_{OR}	Recommended Output Current				70	mA
LinReg	Line Regulation	$V_{IN} = 4.7 \text{ V} \rightarrow 9.7 \text{ V}$		7	35	mV
LoaReg	Load Regulation	$I_O = 0 \text{ mA to } 30 \text{ mA}$		20	110	mV
		$I_O = 0 \text{ mA to } 60 \text{ mA}$		40	100	mV
RR	Ripple Rejection	100 mV(rms), $f = 400 \text{ Hz}$ $V_{IN} = 5.2 \text{ V}, I_O = 10 \text{ mA}$		55		dB
$\Delta V/\Delta T$	V_O Temperature Coefficient	$V_{IN} = 5.2 \text{ V}, I_O = 10 \text{ mA}$ $-20 \text{ }^\circ\text{C} \leq T_A \leq 75 \text{ }^\circ\text{C}$		± 0.4		mV/ $^\circ\text{C}$
V_N	Output Noise Voltage	$V_{IN} = 4.5 \text{ V}, I_O = 10 \text{ mA}$		180		$\mu\text{V(rms)}$
Control Pin						
I_{CONT}	Control Pin Current	On Mode		35	120	μA
V_{Coff}	Control Pin Voltage	Off Mode	$V_{IN}-0.2$		V_{IN}	V
V_{Con}	Control Pin Voltage	On Mode	0		0.6	V

Note 2: I_O (Load Current) is current when V_O drop down 0.3V from V_O at $I_O = 30 \text{ mA}$.

TK11440 ELECTRICAL CHARACTERISTICS

SYMBOL	PARAMETER	TEST CONDITION	MIN	TYP	MAX	UNITS
I_{IN1}	Supply Current 1	$V_{IN} = 5\text{ V}, I_O = 0\text{ mA}$		500	900	μA
I_{IN2}	Supply Current 2	$V_{IN} = 3.0\text{ V}, I_O = 0\text{ mA}$		1	2.5	μA
I_{INS}	Standby Current	$V_{IN} = 10\text{ V}, \text{Output Off}$			0.1	μA
V_O	Output Voltage Regulation	$V_{IN} = 5\text{ V}, I_O = 30\text{ mA}$	3.86	4.0	3.1	%
V_{DROP}	Dropout Voltage	$I_O = 30\text{ mA}$		0.12	0.3	V
I_O	Output Current	(Note 2)	70	110		mA
I_{OR}	Recommended Output Current				70	mA
LinReg	Line Regulation	$V_{IN} = 5\text{ V} \rightarrow 10\text{ V}$		8	40	mV
LoaReg	Load Regulation	$I_O = 0\text{ mA to } 30\text{ mA}$		24	60	mV
		$I_O = 0\text{ mA to } 60\text{ mA}$		48	100	mV
RR	Ripple Rejection	100 mV(rms), $f = 400\text{ Hz}$ $V_{IN} = 5.5\text{ V}, I_O = 10\text{ mA}$		55		dB
$\Delta V/\Delta T$	V_O Temperature Coefficient	$V_{IN} = 5.5\text{ V}, I_O = 10\text{ mA}$ $-20\text{ }^\circ\text{C} \leq T_A \leq 75\text{ }^\circ\text{C}$		± 0.4		mV/ $^\circ\text{C}$
V_N	Output Noise Voltage	$V_{IN} = 5.5\text{ V}, I_O = 10\text{ mA}$		180		$\mu\text{V(rms)}$
Control Pin						
I_{CONT}	Control Pin Current	On Mode		35	120	μA
V_{Coff}	Control Pin Voltage	Off Mode	$V_{IN}-0.2$		V_{IN}	V
V_{Con}	Control Pin Voltage	On Mode	0		0.6	V

Note 2: I_O (Load Current) is current when V_O drop down 0.3V from V_O at $I_O = 30\text{ mA}$.

TK11445 ELECTRICAL CHARACTERISTICS

SYMBOL	PARAMETER	TEST CONDITION	MIN	TYP	MAX	UNITS
I_{IN1}	Supply Current 1	$V_{IN} = 5\text{ V}, I_O = 0\text{ mA}$		500	900	μA
I_{IN2}	Supply Current 2	$V_{IN} = 3.5\text{ V}, I_O = 0\text{ mA}$		1	2.5	μA
I_{INS}	Standby Current	$V_{IN} = 10\text{ V}, \text{Output Off}$			0.1	μA
V_O	Output Voltage Regulation	$V_{IN} = 5.5\text{ V}, I_O = 30\text{ mA}$	4.34	4.5	4.66	%
V_{DROD}	Dropout Voltage	$I_O = 30\text{ mA}$		0.12	0.3	V
I_O	Output Current	(Note 2)	70	110		mA
I_{OR}	Recommended Output Current				70	mA
LinReg	Line Regulation	$V_{IN} = 5.5\text{ V} \rightarrow 10.5\text{ V}$		8	40	mV
LoaReg	Load Regulation	$I_O = 0\text{ mA to }30\text{ mA}$		25	65	mV
		$I_O = 0\text{ mA to }60\text{ mA}$		55	110	mV
RR	Ripple Rejection	100 mV(rms), $f = 400\text{ Hz}$ $V_{IN} = 6\text{ V}, I_O = 10\text{ mA}$		55		dB
$\Delta V/\Delta T$	V_O Temperature Coefficient	$V_{IN} = 6\text{ V}, I_O = 10\text{ mA}$ $-20\text{ }^\circ\text{C} \leq T_A \leq 75\text{ }^\circ\text{C}$		± 0.5		mV/ $^\circ\text{C}$
V_N	Output Noise Voltage	$V_{IN} = 6\text{ V}, I_O = 10\text{ mA}$		180		$\mu\text{V(rms)}$
Control Pin						
I_{CONT}	Control Pin Current	On Mode		35	120	μA
V_{Coff}	Control Pin Voltage	Off Mode	$V_{IN}-0.2$		V_{IN}	V
V_{Con}	Control Pin Voltage	On Mode	0		0.6	V

Note 2: I_O (Load Current) is current when V_O drop down 0.3V from V_O at $I_O = 30\text{ mA}$.

TK11447 ELECTRICAL CHARACTERISTICS

SYMBOL	PARAMETER	TEST CONDITION	MIN	TYP	MAX	UNITS
I_{IN1}	Supply Current 1	$V_{IN} = 5.7 \text{ V}, I_O = 0 \text{ mA}$		500	900	μA
I_{IN2}	Supply Current 2	$V_{IN} = 3.7 \text{ V}, I_O = 0 \text{ mA}$		1	2.5	μA
I_{INS}	Standby Current	$V_{IN} = 10 \text{ V}, \text{Output Off}$			0.1	μA
V_O	Output Voltage Regulation	$V_{IN} = 5.7 \text{ V}, I_O = 30 \text{ mA}$	4.58	4.75	4.92	%
V_{DROP}	Dropout Voltage	$I_O = 30 \text{ mA}$		0.12	0.3	V
I_O	Output Current	(Note 2)	70	110		mA
I_{OR}	Recommended Output Current				70	mA
LinReg	Line Regulation	$V_{IN} = 5.7 \text{ V} \rightarrow 10.7 \text{ V}$		8	40	mV
LoaReg	Load Regulation	$I_O = 0 \text{ mA to } 30 \text{ mA}$		25	70	mV
		$I_O = 0 \text{ mA to } 60 \text{ mA}$		50	120	mV
RR	Ripple Rejection	100 mV(rms), $f = 400 \text{ Hz}$ $V_{IN} = 6.2 \text{ V}, I_O = 10 \text{ mA}$		55		dB
$\Delta V/\Delta T$	V_O Temperature Coefficient	$V_{IN} = 6.2 \text{ V}, I_O = 10 \text{ mA}$ $-20 \text{ }^\circ\text{C} \leq T_A \leq 75 \text{ }^\circ\text{C}$		± 0.6		mV/ $^\circ\text{C}$
V_N	Output Noise Voltage	$V_{IN} = 6.2 \text{ V}, I_O = 10 \text{ mA}$		180		$\mu\text{V(rms)}$
Control Pin						
I_{CONT}	Control Pin Current	On Mode		35	120	μA
V_{Coff}	Control Pin Voltage	Off Mode	$V_{IN}-0.2$		V_{IN}	V
V_{Con}	Control Pin Voltage	On Mode	0		0.6	V

Note 2: I_O (Load Current) is current when V_O drop down 0.3V from V_O at $I_O = 30 \text{ mA}$.

TK11450 ELECTRICAL CHARACTERISTICS

SYMBOL	PARAMETER	TEST CONDITION	MIN	TYP	MAX	UNITS
I_{IN1}	Supply Current 1	$V_{IN} = 6.0 \text{ V}, I_O = 0 \text{ mA}$		500	900	μA
I_{IN2}	Supply Current 2	$V_{IN} = 4.0 \text{ V}, I_O = 0 \text{ mA}$		1	2.5	μA
I_{INS}	Standby Current	$V_{IN} = 10 \text{ V}, \text{Output Off}$			0.1	μA
V_O	Output Voltage Regulation	$V_{IN} = 6.0 \text{ V}, I_O = 30 \text{ mA}$	4.83	5.0	5.17	%
V_{DROP}	Dropout Voltage	$I_O = 30 \text{ mA}$		0.12	0.3	V
I_O	Output Current	(Note 2)	70	110		mA
I_{OR}	Recommended Output Current				70	mA
LinReg	Line Regulation	$V_{IN} = 6 \text{ V} \rightarrow 11 \text{ V}$		8	40	mV
LoaReg	Load Regulation	$I_O = 0 \text{ mA to } 30 \text{ mA}$		25	70	mV
		$I_O = 0 \text{ mA to } 60 \text{ mA}$		60	120	mV
RR	Ripple Rejection	100 mV(rms), $f = 400 \text{ Hz}$ $V_{IN} = 6.5 \text{ V}, I_O = 10 \text{ mA}$		55		dB
$\Delta V/\Delta T$	V_O Temperature Coefficient	$V_{IN} = 6.5 \text{ V}, I_O = 10 \text{ mA}$ $-20 \text{ }^\circ\text{C} \leq T_A \leq 75 \text{ }^\circ\text{C}$		± 0.6		mV/ $^\circ\text{C}$
V_N	Output Noise Voltage	$V_{IN} = 6.5 \text{ V}, I_O = 10 \text{ mA}$		180		$\mu\text{V(rms)}$
Control Pin						
I_{CONT}	Control Pin Current	On Mode		35	120	μA
V_{Coff}	Control Pin Voltage	Off Mode	$V_{IN}-0.2$		V_{IN}	V
V_{Con}	Control Pin Voltage	On Mode	0		0.6	V

Note 2: I_O (Load Current) is current when V_O drop down 0.3V from V_O at $I_O = 30 \text{ mA}$.

TK11455 ELECTRICAL CHARACTERISTICS

SYMBOL	PARAMETER	TEST CONDITION	MIN	TYP	MAX	UNITS
I_{IN1}	Supply Current 1	$V_{IN} = 6.5 \text{ V}, I_O = 0 \text{ mA}$		500	900	μA
I_{IN2}	Supply Current 2	$V_{IN} = 4.5 \text{ V}, I_O = 0 \text{ mA}$		1	2.5	μA
I_{INS}	Standby Current	$V_{IN} = 10 \text{ V}, \text{Output Off}$			0.1	μA
V_O	Output Voltage Regulation	$V_{IN} = 6.5 \text{ V}, I_O = 30 \text{ mA}$	5.31	5.5	5.69	%
V_{DROP}	Dropout Voltage	$I_O = 30 \text{ mA}$		0.12	0.3	V
I_O	Output Current	(Note 2)	70	110		mA
I_{OR}	Recommended Output Current				70	mA
LinReg	Line Regulation	$V_{IN} = 6.5 \text{ V} \rightarrow 11.5 \text{ V}$		8	40	mV
LoaReg	Load Regulation	$I_O = 0 \text{ mA to } 30 \text{ mA}$		30	75	mV
		$I_O = 0 \text{ mA to } 60 \text{ mA}$		65	130	mV
RR	Ripple Rejection	100 mV(rms), $f = 400 \text{ Hz}$ $V_{IN} = 7.0 \text{ V}, I_O = 10 \text{ mA}$		55		dB
$\Delta V/\Delta T$	V_O Temperature Coefficient	$V_{IN} = 7.0 \text{ V}, I_O = 10 \text{ mA}$ $-20 \text{ }^\circ\text{C} \leq T_A \leq 75 \text{ }^\circ\text{C}$		± 0.7		mV/ $^\circ\text{C}$
V_N	Output Noise Voltage	$V_{IN} = 7.0 \text{ V}, I_O = 10 \text{ mA}$		180		$\mu\text{V(rms)}$
Control Pin						
I_{CONT}	Control Pin Current	On Mode		35	120	μA
V_{Coff}	Control Pin Voltage	Off Mode	$V_{IN}-0.2$		V_{IN}	V
V_{Con}	Control Pin Voltage	On Mode	0		0.6	V

Note 2: I_O (Load Current) is current when V_O drop down 0.3V from V_O at $I_O = 30 \text{ mA}$.

TK11460 ELECTRICAL CHARACTERISTICS

SYMBOL	PARAMETER	TEST CONDITION	MIN	TYP	MAX	UNITS
I_{IN1}	Supply Current 1	$V_{IN} = 7.0 \text{ V}, I_O = 0 \text{ mA}$		500	900	μA
I_{IN2}	Supply Current 2	$V_{IN} = 5.0 \text{ V}, I_O = 0 \text{ mA}$		1	3.0	μA
I_{INS}	Standby Current	$V_{IN} = 10 \text{ V}, \text{Output Off}$			0.1	μA
V_O	Output Voltage Regulation	$V_{IN} = 7.0 \text{ V}, I_O = 30 \text{ mA}$	5.79	6.0	6.21	%
V_{DROP}	Dropout Voltage	$I_O = 30 \text{ mA}$		0.12	0.3	V
I_O	Output Current	(Note 2)	70	110		mA
I_{OR}	Recommended Output Current				70	mA
LinReg	Line Regulation	$V_{IN} = 7.0 \text{ V} \rightarrow 12 \text{ V}$		8	40	mV
LoaReg	Load Regulation	$I_O = 0 \text{ mA to } 30 \text{ mA}$		30	80	mV
		$I_O = 0 \text{ mA to } 60 \text{ mA}$		65	140	mV
RR	Ripple Rejection	100 mV(rms), $f = 400 \text{ Hz}$ $V_{IN} = 7.5 \text{ V}, I_O = 10 \text{ mA}$		55		dB
$\Delta V/\Delta T$	V_O Temperature Coefficient	$V_{IN} = 7.5 \text{ V}, I_O = 10 \text{ mA}$ $-20 \text{ }^\circ\text{C} \leq T_A \leq 75 \text{ }^\circ\text{C}$		± 0.7		mV/ $^\circ\text{C}$
V_N	Output Noise Voltage	$V_{IN} = 7.5 \text{ V}, I_O = 10 \text{ mA}$		180		$\mu\text{V(rms)}$
Control Pin						
I_{CONT}	Control Pin Current	On Mode		35	120	μA
V_{Coff}	Control Pin Voltage	Off Mode	$V_{IN}-0.2$		V_{IN}	V
V_{Con}	Control Pin Voltage	On Mode	0		0.6	V

Note 2: I_O (Load Current) is current when V_O drop down 0.3V from V_O at $I_O = 30 \text{ mA}$.

TK11480 ELECTRICAL CHARACTERISTICS

SYMBOL	PARAMETER	TEST CONDITION	MIN	TYP	MAX	UNITS
I_{IN1}	Supply Current 1	$V_{IN} = 9.0 \text{ V}, I_O = 0 \text{ mA}$		500	900	μA
I_{IN2}	Supply Current 2	$V_{IN} = 7.0 \text{ V}, I_O = 0 \text{ mA}$		1	3.0	μA
I_{INS}	Standby Current	$V_{IN} = 10 \text{ V}, \text{Output Off}$			0.1	μA
V_O	Output Voltage Regulation	$V_{IN} = 9.0 \text{ V}, I_O = 30 \text{ mA}$	7.72	8.0	8.28	%
V_{DROP}	Dropout Voltage	$I_O = 30 \text{ mA}$		0.12	0.3	V
I_O	Output Current	(Note 2)	70	110		mA
I_{OR}	Recommended Output Current				70	mA
LinReg	Line Regulation	$V_{IN} = 9 \text{ V} \rightarrow 13 \text{ V}$		8	40	mV
LoaReg	Load Regulation	$I_O = 0 \text{ mA to } 30 \text{ mA}$		30	100	mV
		$I_O = 0 \text{ mA to } 60 \text{ mA}$		65	180	mV
RR	Ripple Rejection	100 mV(rms), $f = 400 \text{ Hz}$ $V_{IN} = 9.5 \text{ V}, I_O = 10 \text{ mA}$		55		dB
$\Delta V/\Delta T$	V_O Temperature Coefficient	$V_{IN} = 9.5 \text{ V}, I_O = 10 \text{ mA}$ $-20 \text{ }^\circ\text{C} \leq T_A \leq 75 \text{ }^\circ\text{C}$		± 0.7		mV/ $^\circ\text{C}$
V_N	Output Noise Voltage	$V_{IN} = 9.5 \text{ V}, I_O = 10 \text{ mA}$		220		$\mu\text{V(rms)}$
Control Pin						
I_{CONT}	Control Pin Current	On Mode		35	120	μA
V_{Coff}	Control Pin Voltage	Off Mode	$V_{IN}-0.2$		V_{IN}	V
V_{Con}	Control Pin Voltage	On Mode	0		0.6	V

Note 2: I_O (Load Current) is current when V_O drop down 0.3V from V_O at $I_O = 30 \text{ mA}$.

TYPICAL PERFORMANCE CHARACTERISTICS

TK11430

OUTPUT VOLTAGE vs
OUTPUT CURRENT

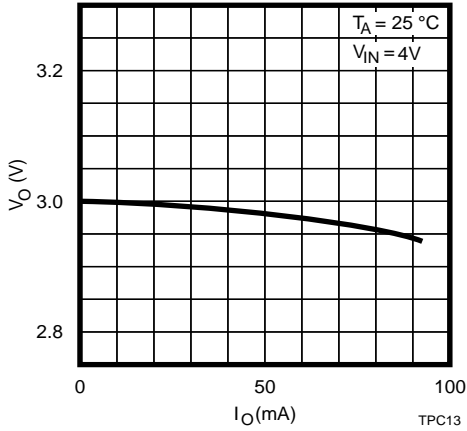

DROPOUT VOLTAGE vs
LOAD CURRENT

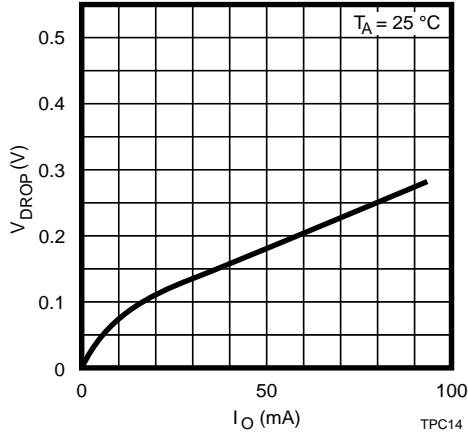

OUTPUT VOLTAGE vs
INPUT VOLTAGE

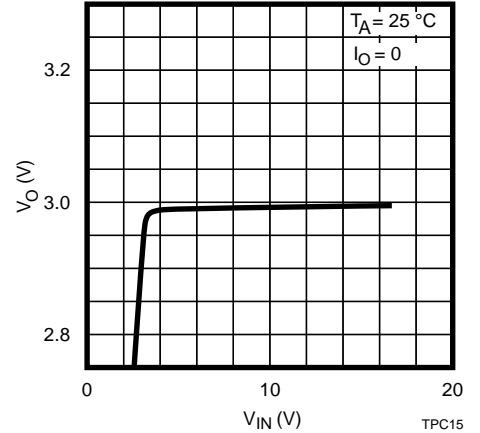

QUIESCENT CURRENT vs
LOAD CURRENT

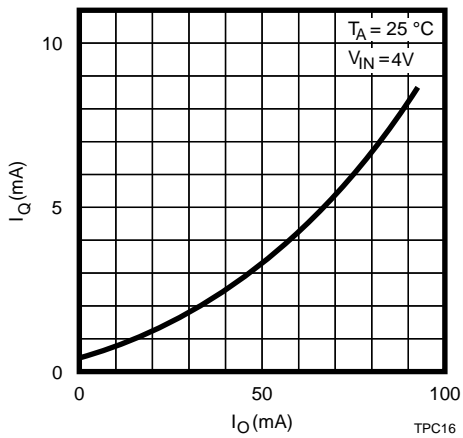

SHORT CIRCUIT
PROTECTION

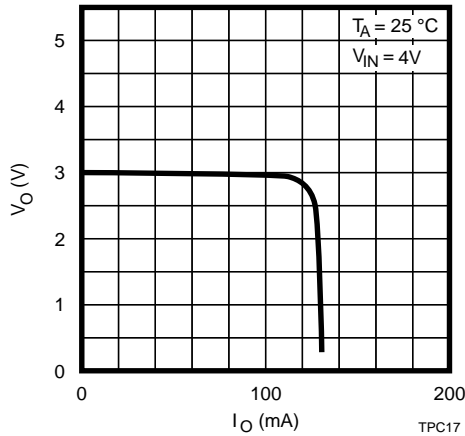

INPUT CURRENT vs
INPUT VOLTAGE

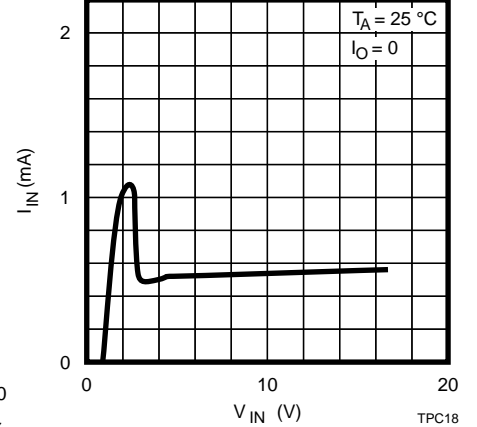

TK11435

OUTPUT VOLTAGE vs
OUTPUT CURRENT

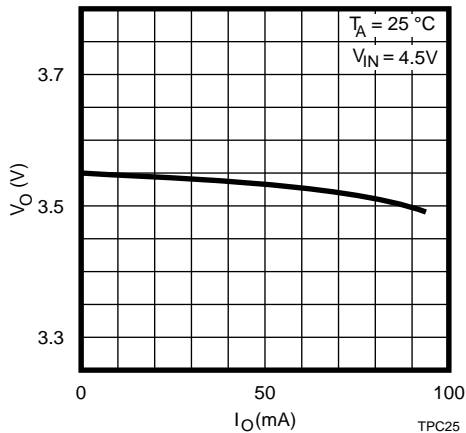

DROPOUT VOLTAGE vs
LOAD CURRENT

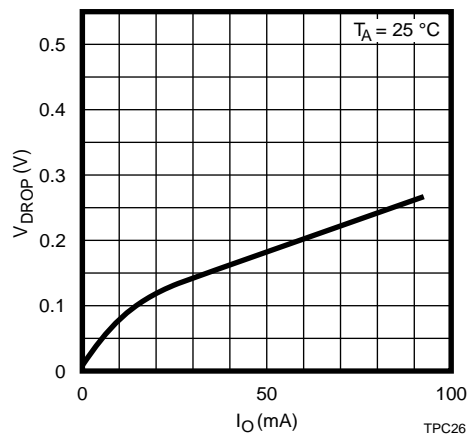

OUTPUT VOLTAGE vs
INPUT VOLTAGE

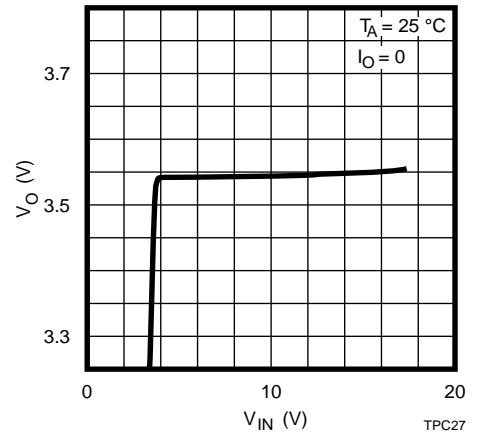

TK114xx

TYPICAL PERFORMANCE CHARACTERISTICS (CONT.)

TK11435 (CONT.)

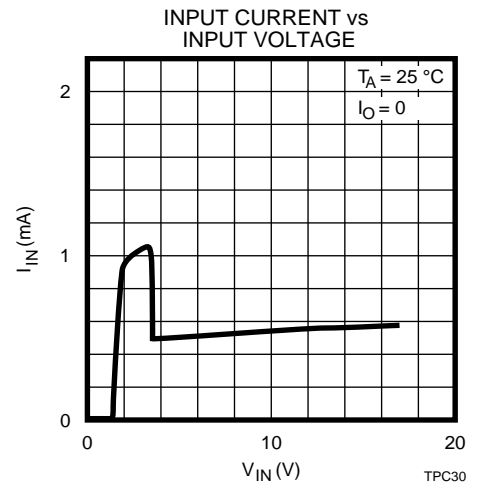
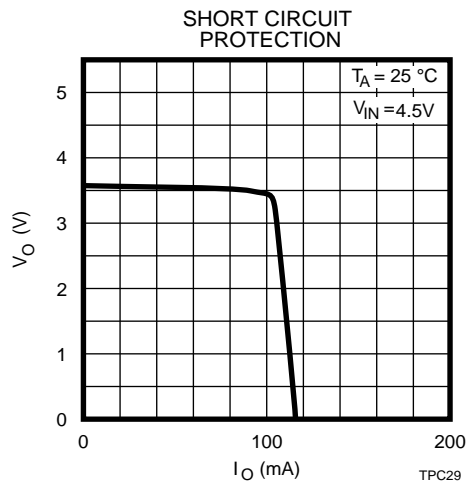
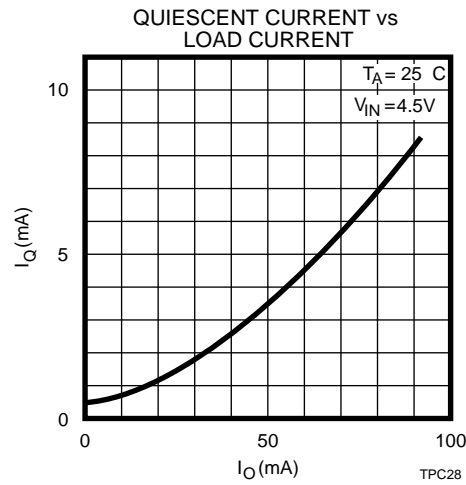

TK11437

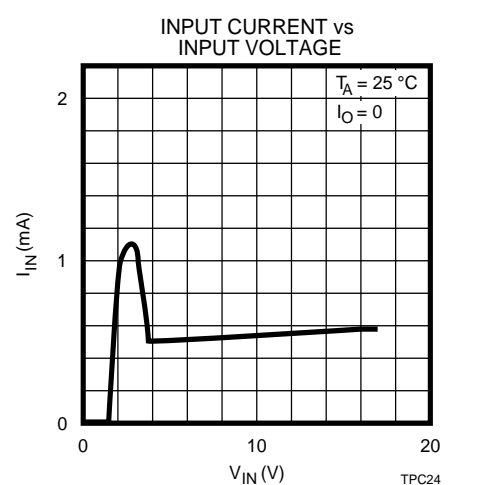
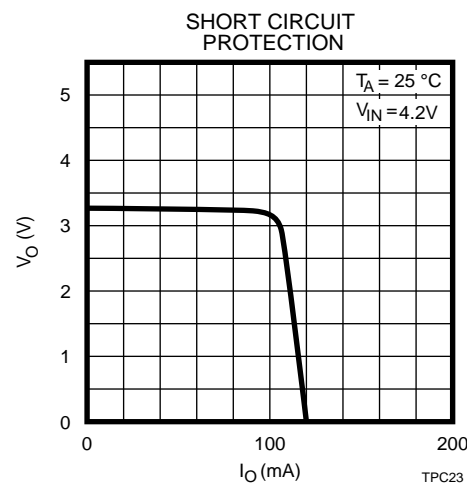
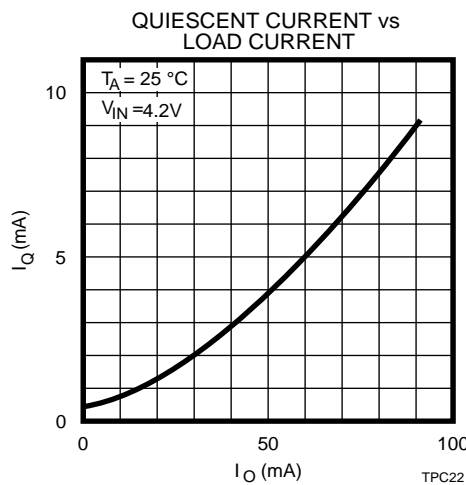
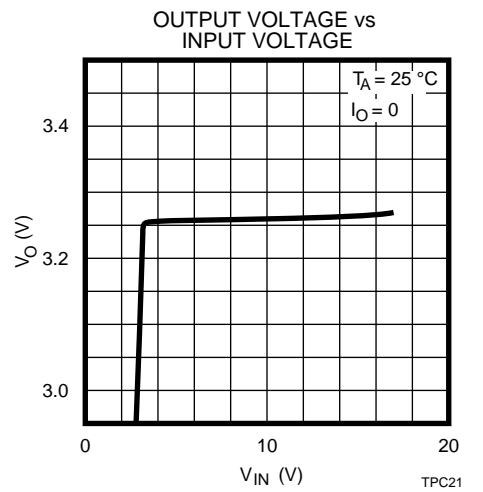
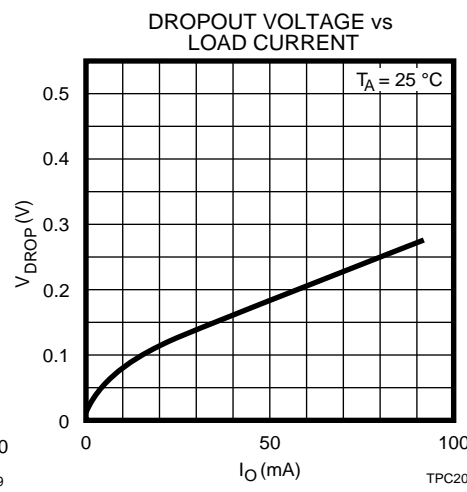
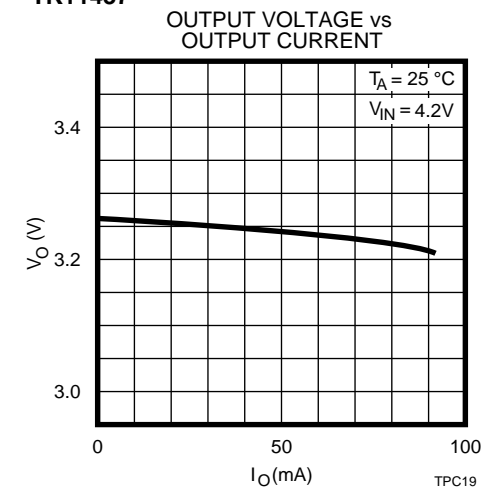

TYPICAL PERFORMANCE CHARACTERISTICS (CONT.)

TK11440

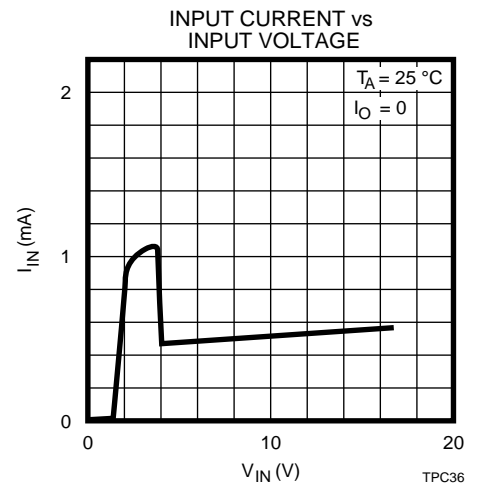
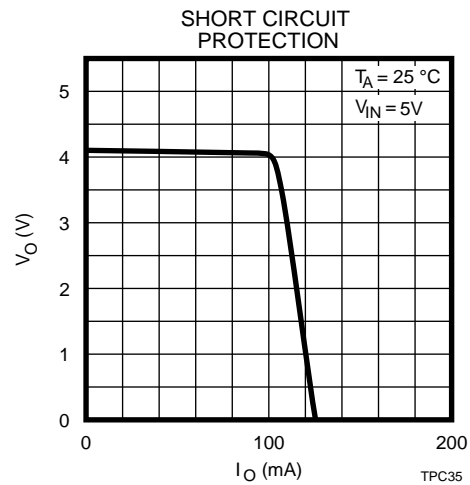
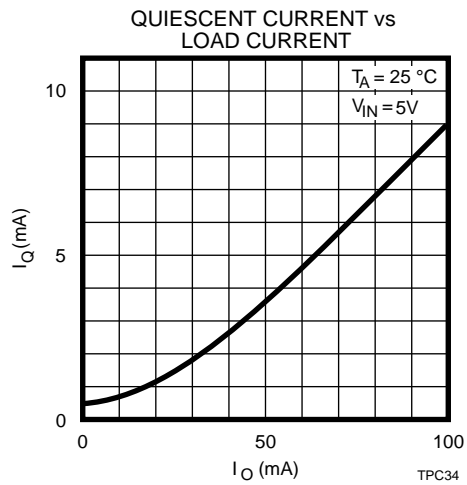
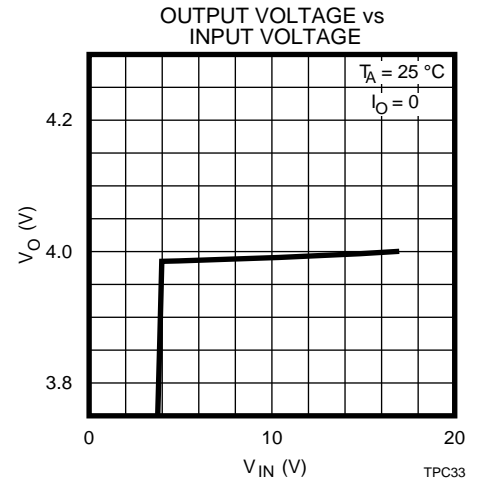
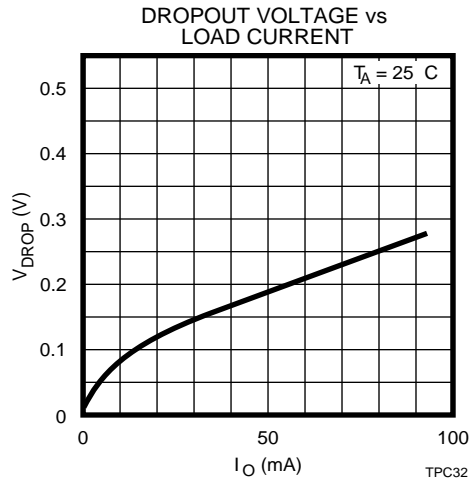
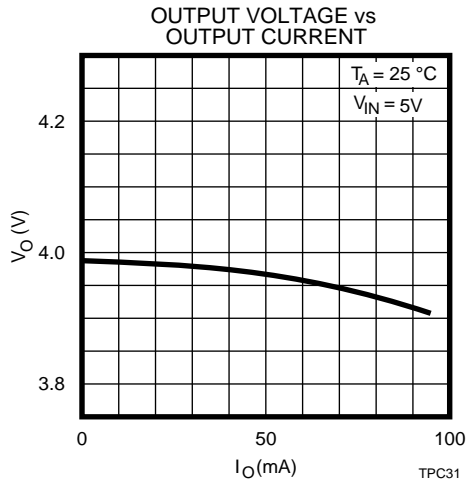

TK11445

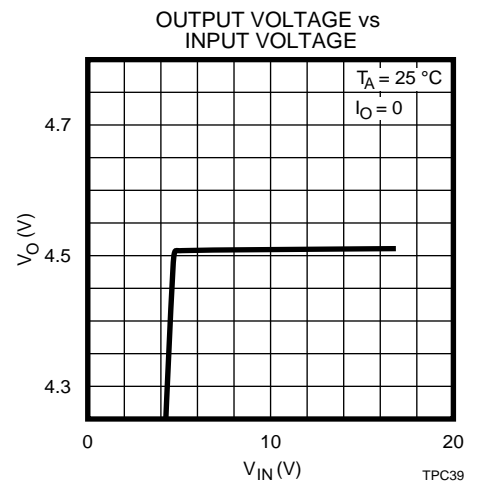
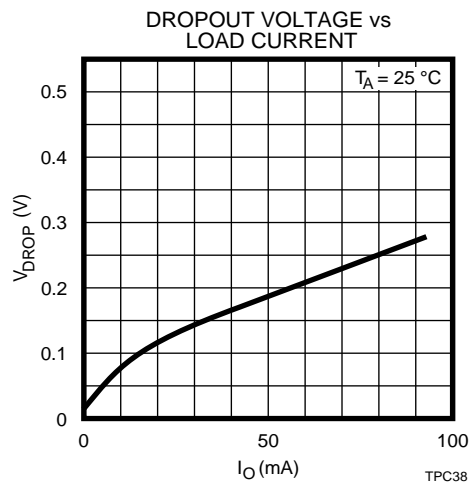
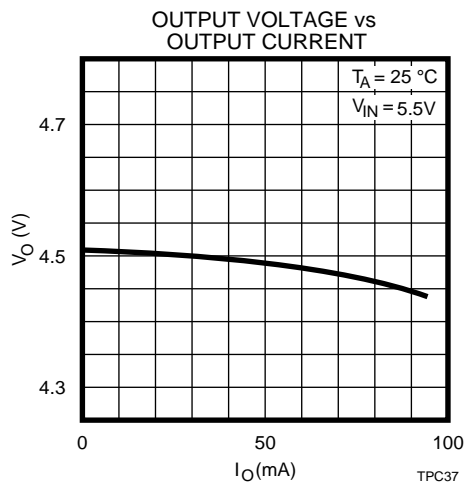

TK114xx

TYPICAL PERFORMANCE CHARACTERISTICS (CONT.)

TK11445 (CONT.)

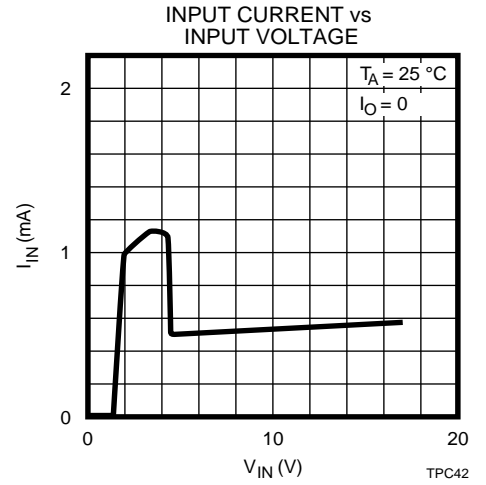
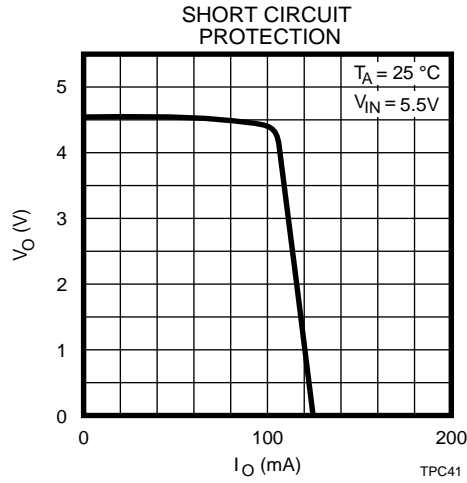
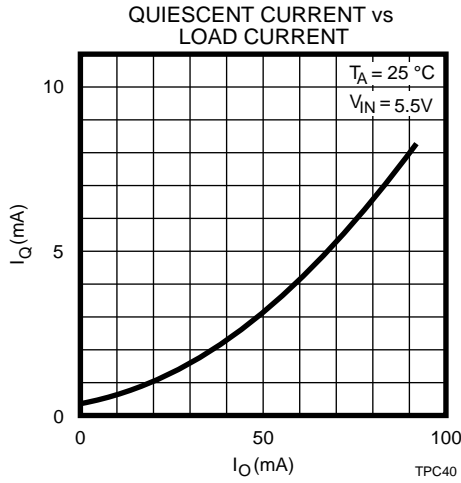

TK11447 OUTPUT VOLTAGE vs OUTPUT CURRENT

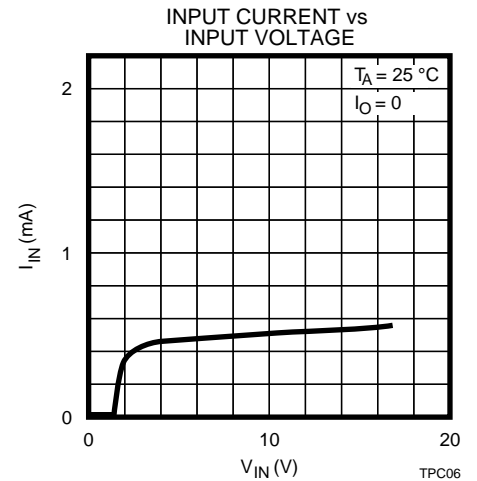
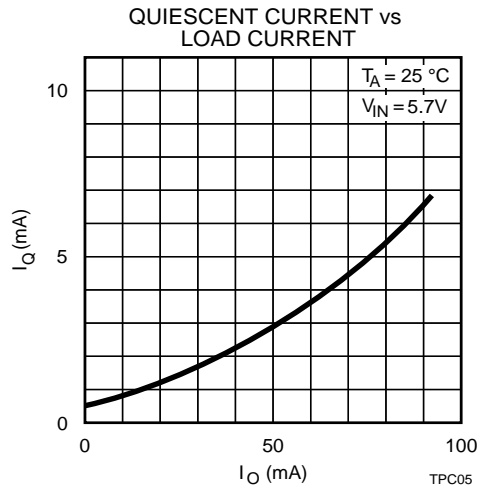
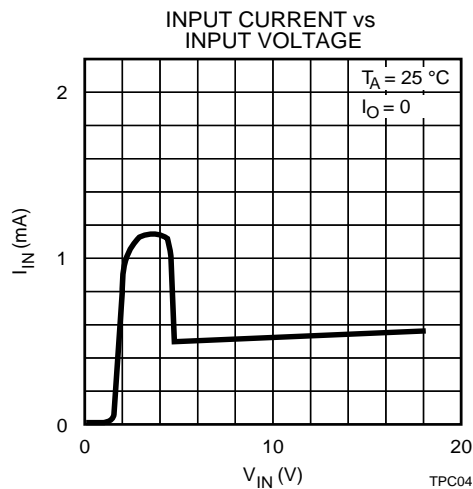
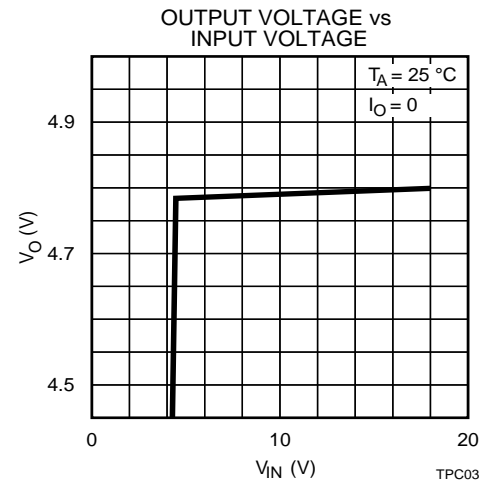
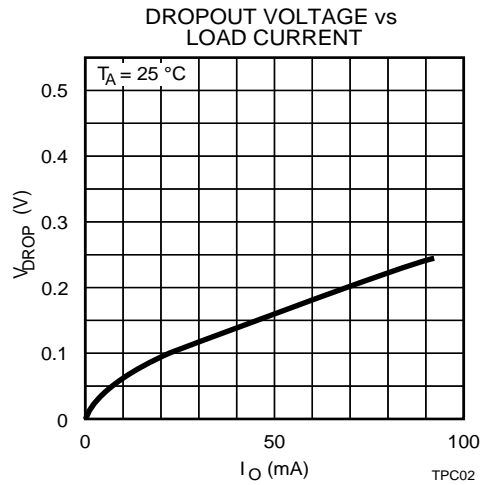
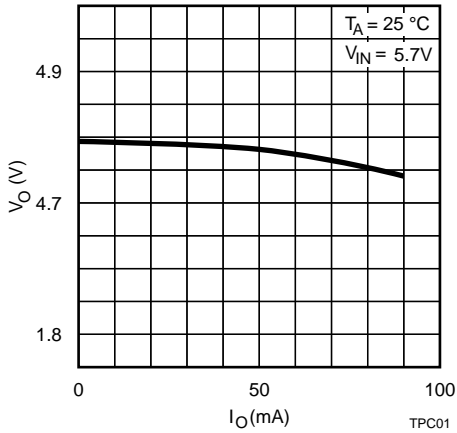

TYPICAL PERFORMANCE CHARACTERISTICS (CONT.)

TK11450

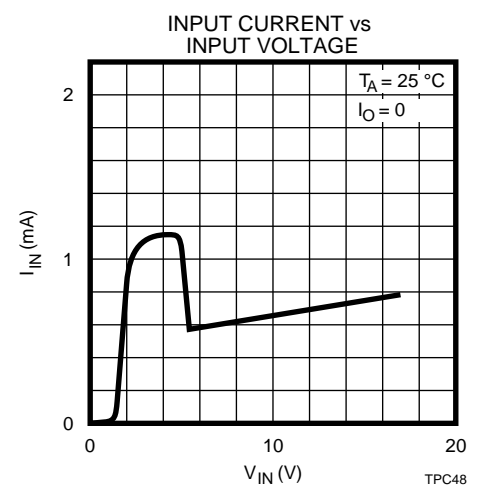
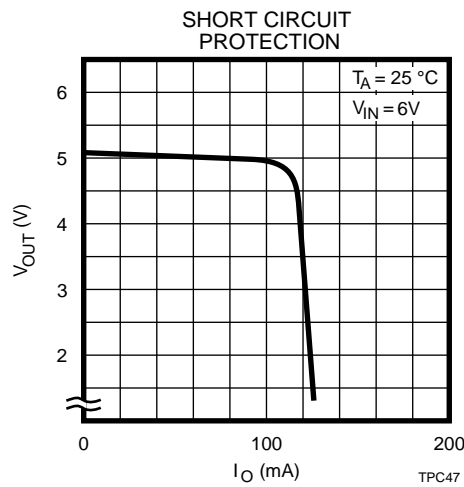
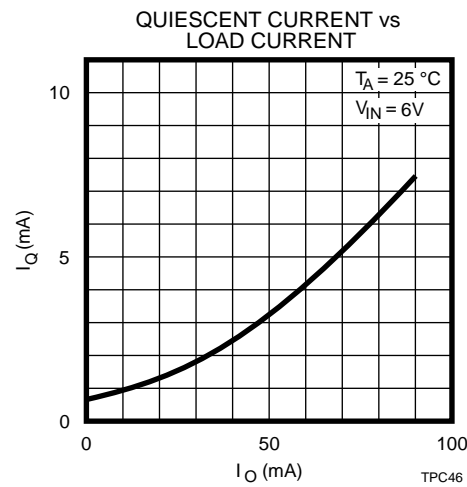
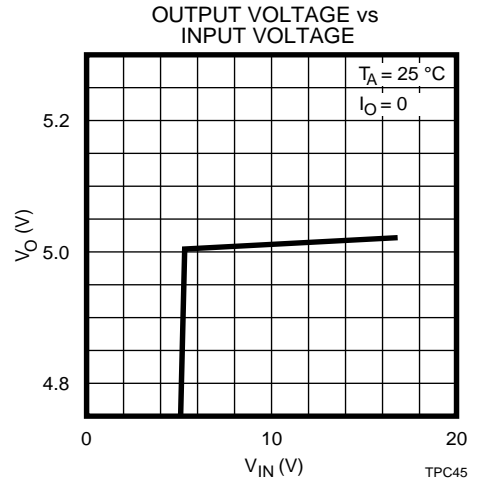
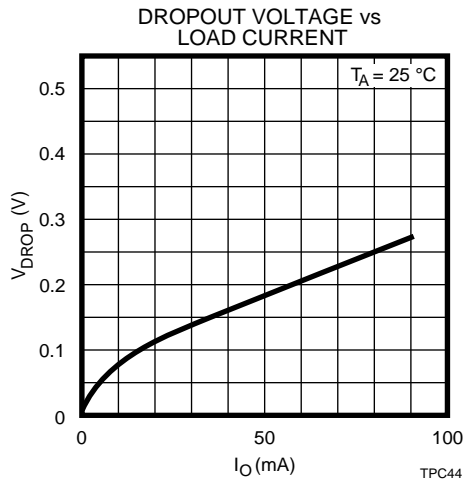
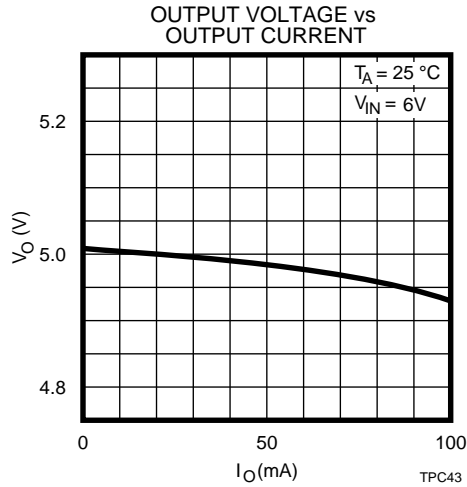

TK11455

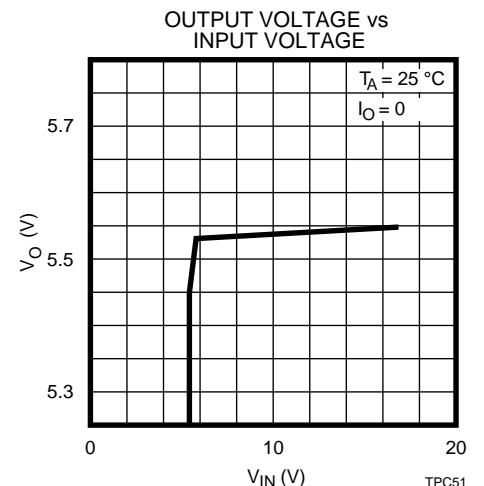
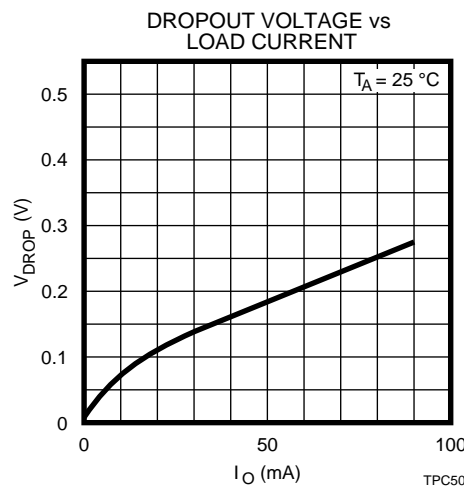
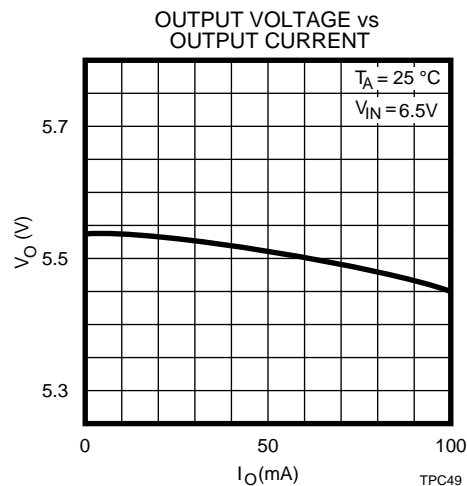

TK114xx

TYPICAL PERFORMANCE CHARACTERISTICS (CONT.)

TK11455 (CONT.)

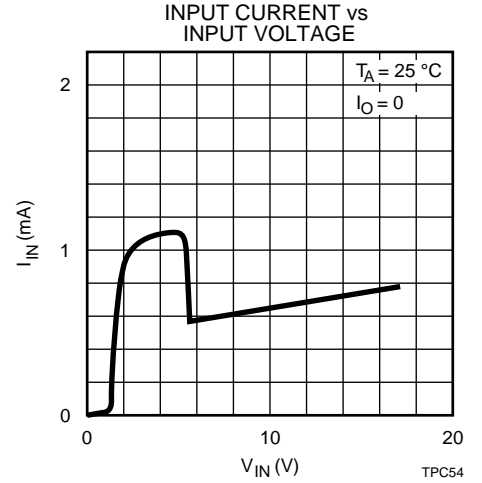
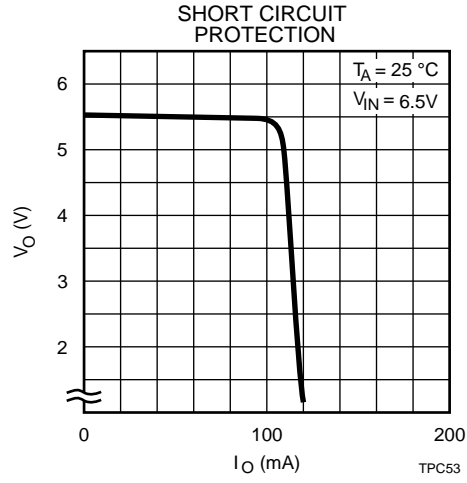
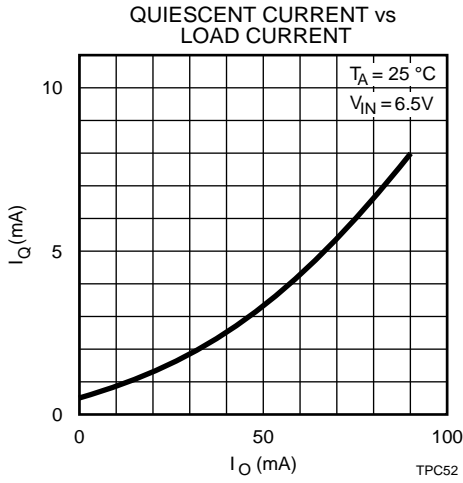

TK11460

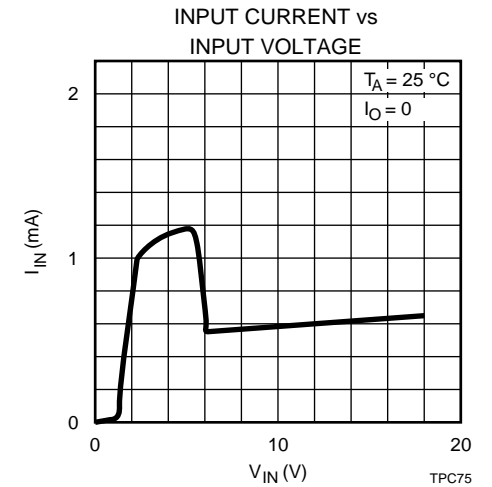
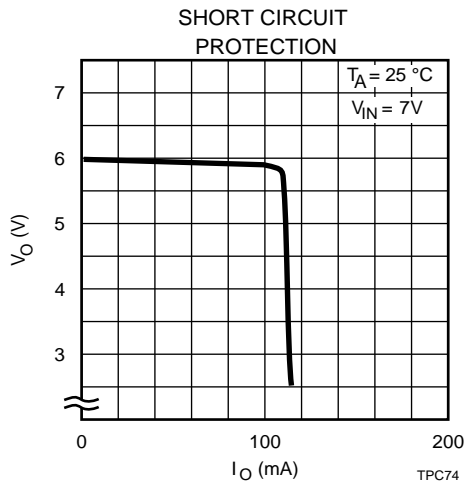
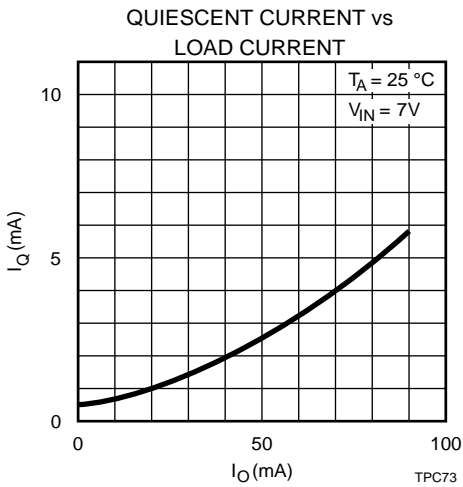
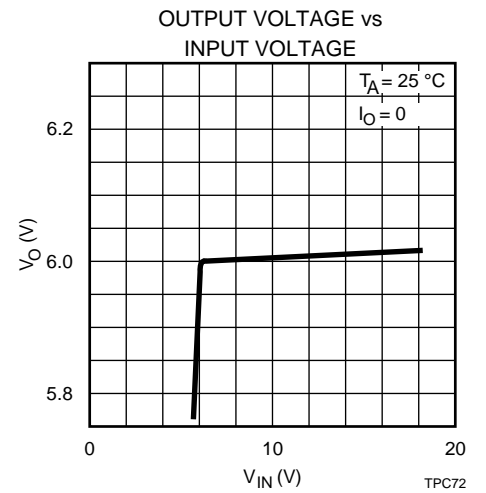
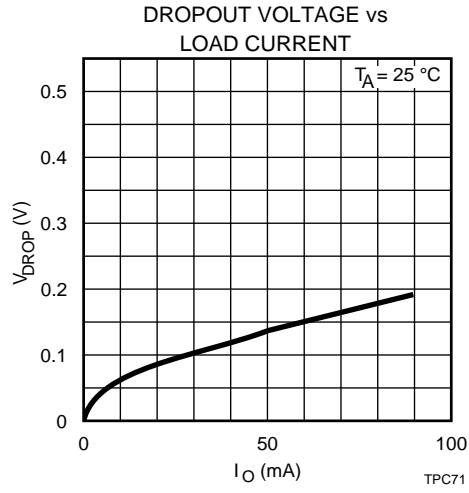
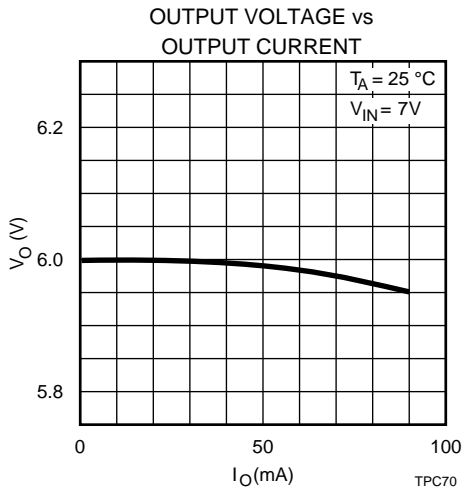

TYPICAL PERFORMANCE CHARACTERISTICS (CONT.)

TK11480

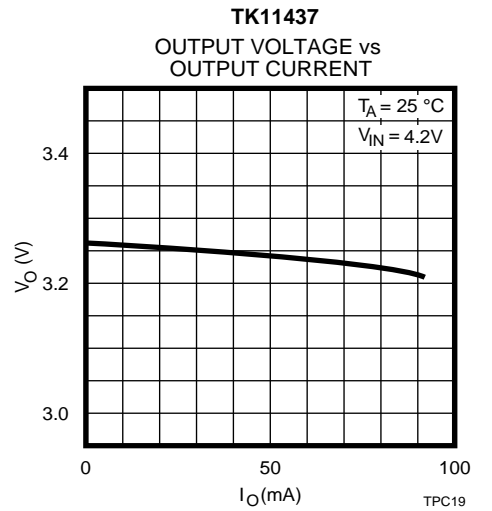
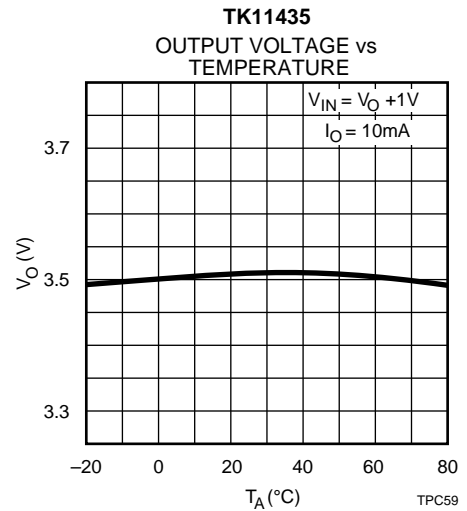
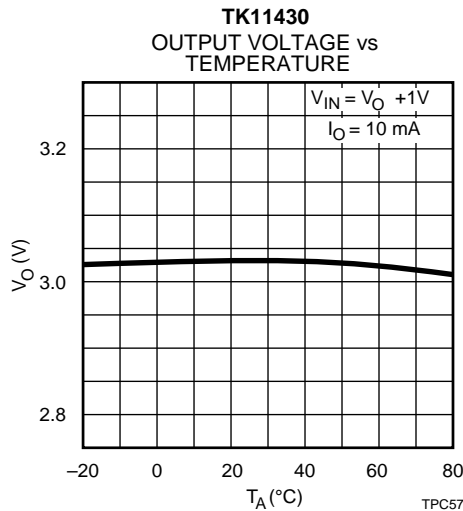
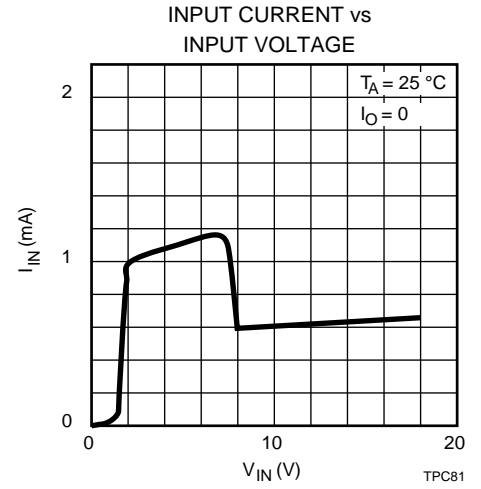
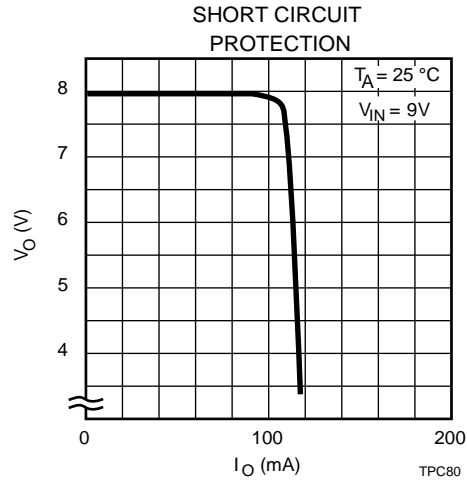
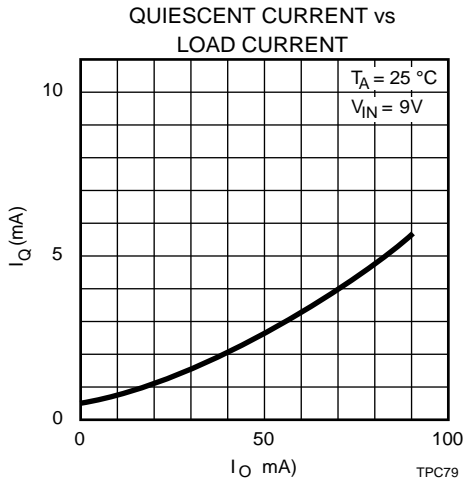
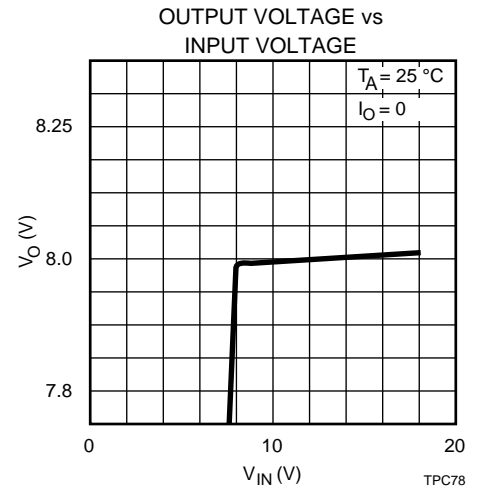
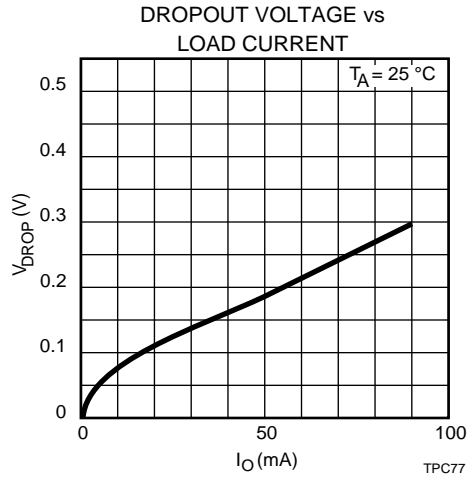
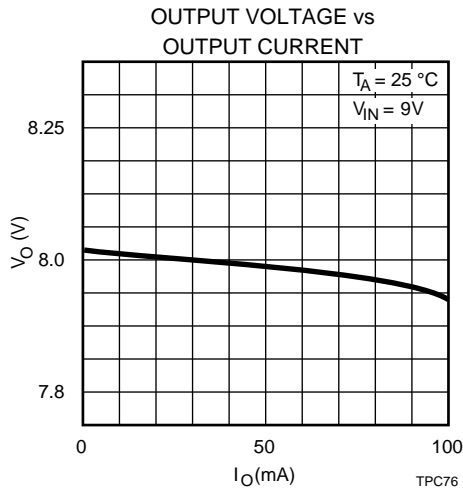

TYPICAL PERFORMANCE CHARACTERISTICS (CONT.)

TK11440

OUTPUT VOLTAGE vs TEMPERATURE

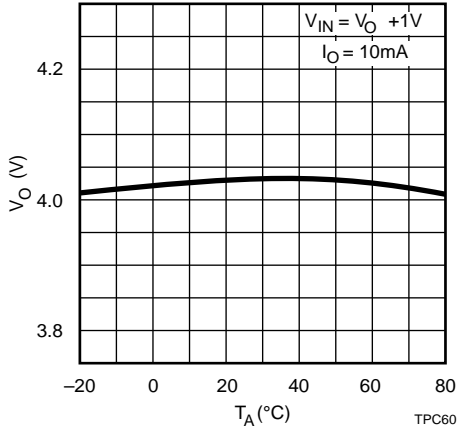

TK11445

OUTPUT VOLTAGE vs TEMPERATURE

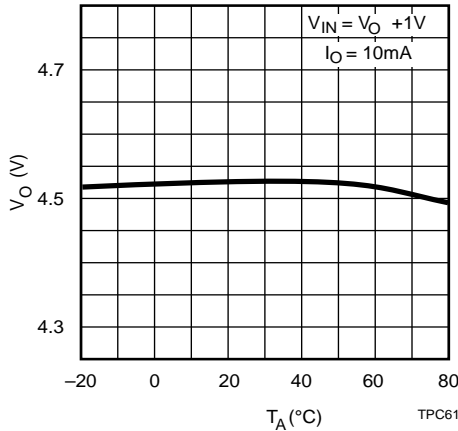

TK11447

OUTPUT VOLTAGE vs TEMPERATURE

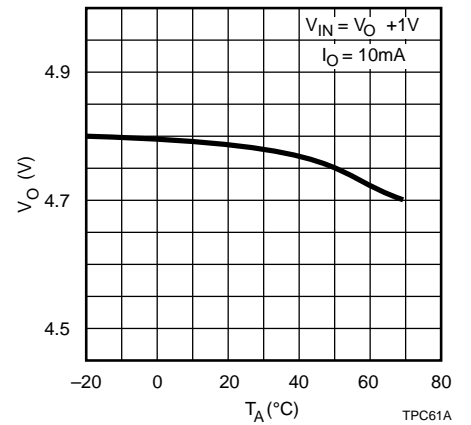

TK11450

OUTPUT VOLTAGE vs TEMPERATURE

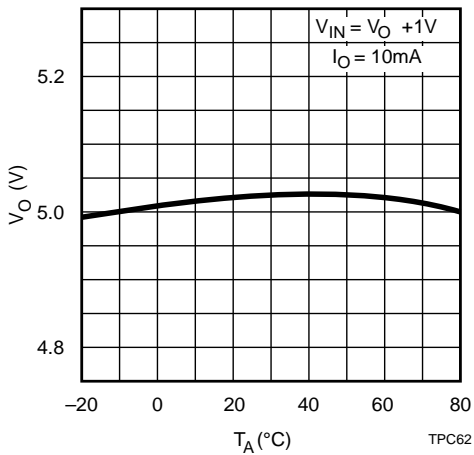

TK11457

OUTPUT VOLTAGE vs TEMPERATURE

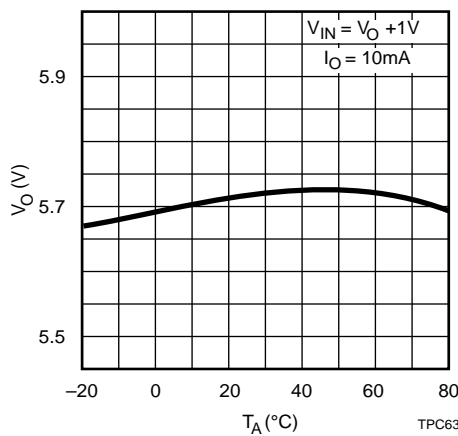

TK11460

OUTPUT VOLTAGE vs TEMPERATURE

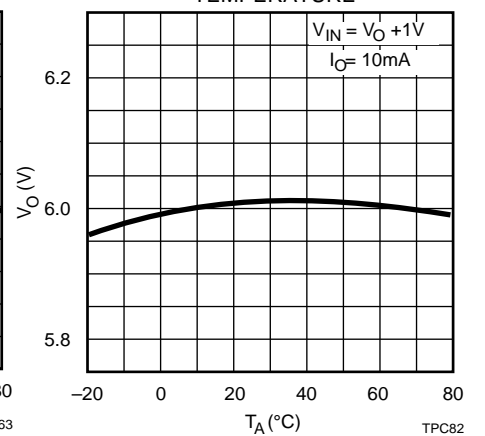

TK11480

OUTPUT VOLTAGE vs TEMPERATURE

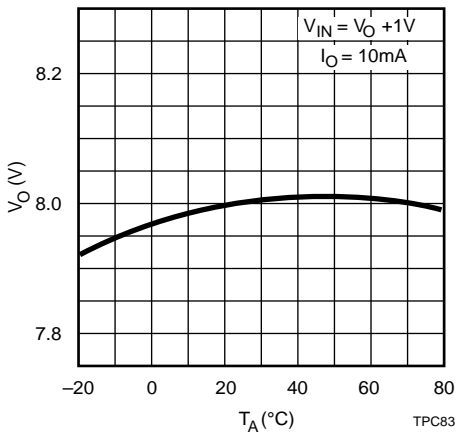

TYPICAL PERFORMANCE CHARACTERISTICS (CONT.)

COMMON CHARACTERISTICS

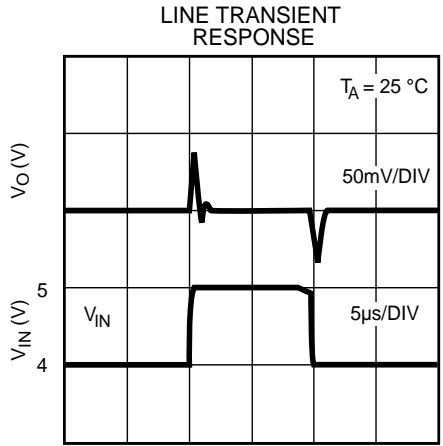

TPC64

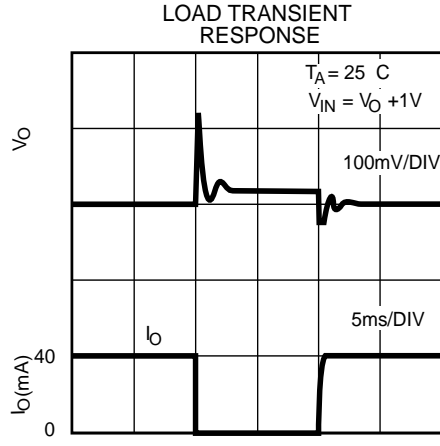

TPC65

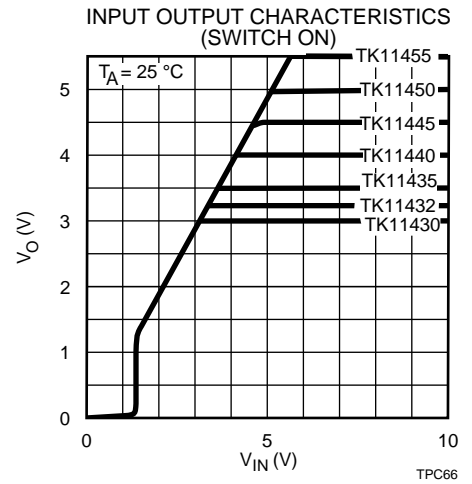

TPC66

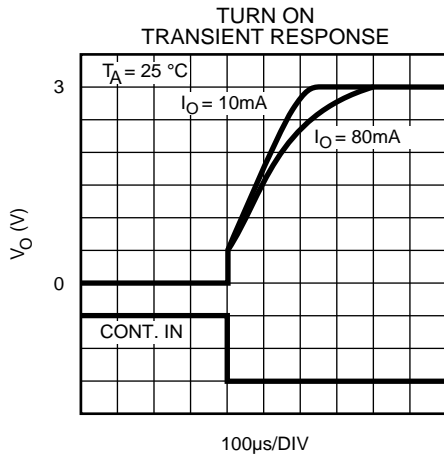

TPC67

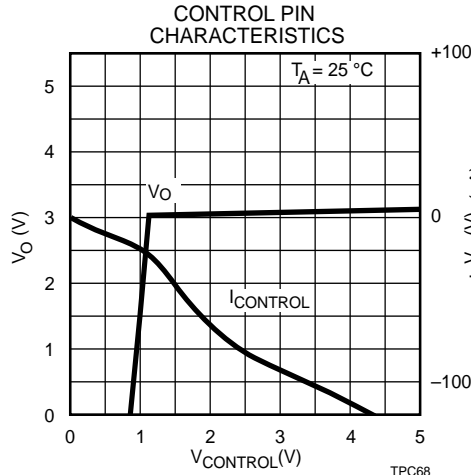

TPC68

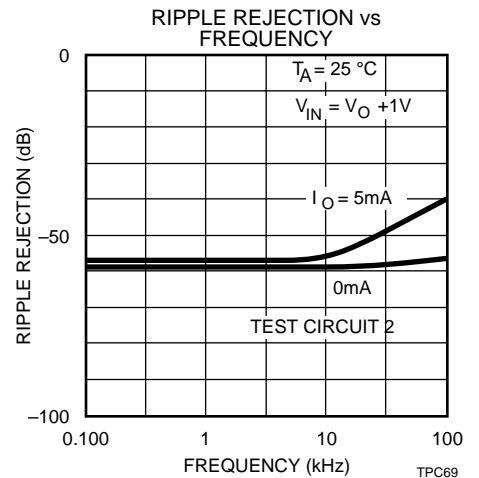
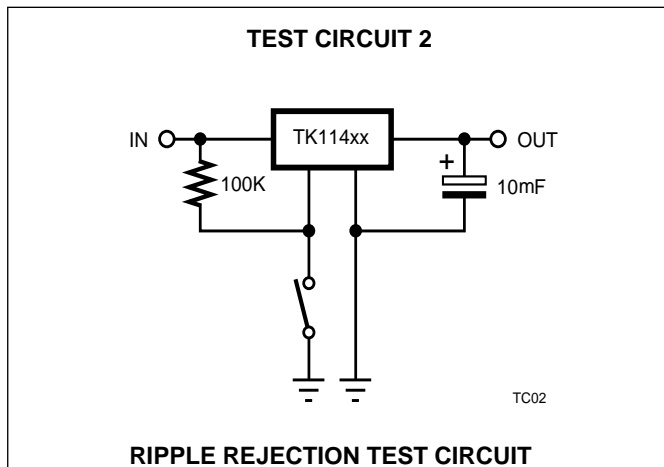
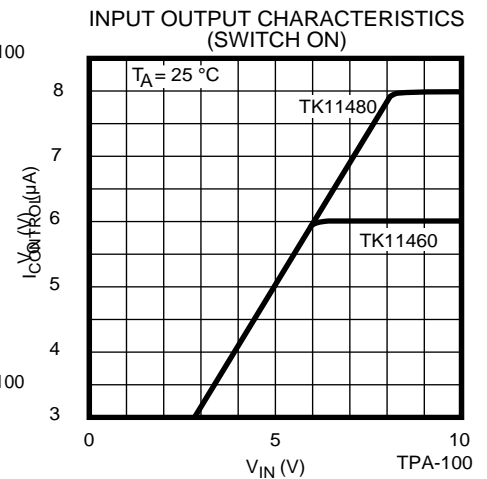

TK114xx

TYPICAL APPLICATIONS

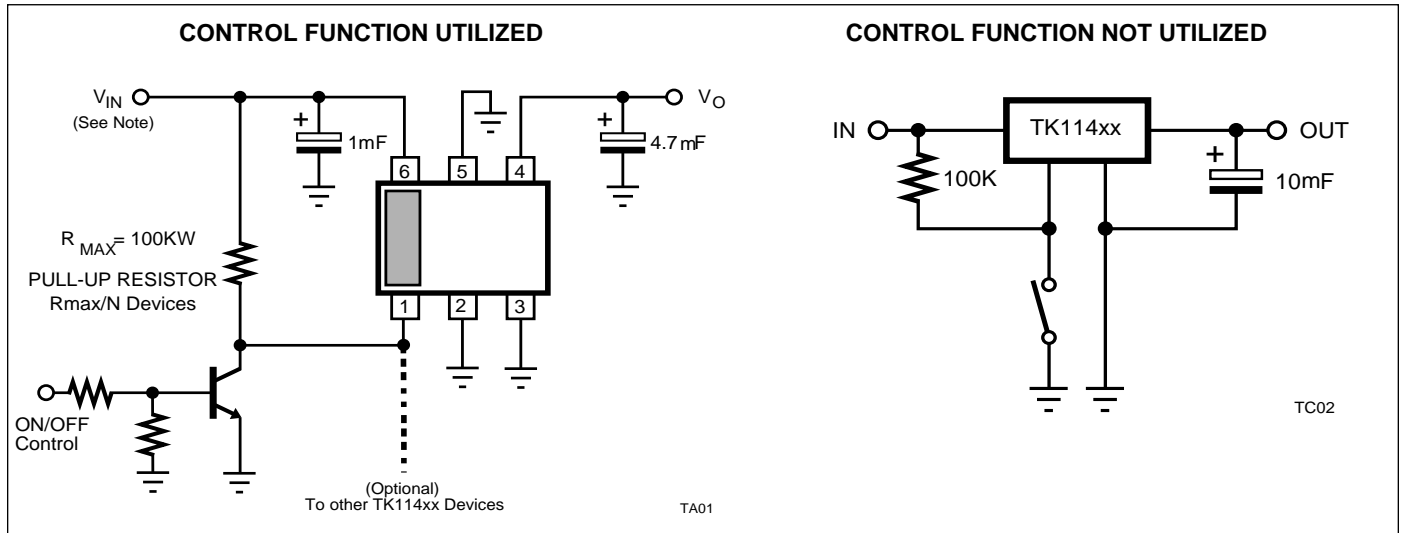

Note: Parallel connection of control pins is allowed if all devices use identical input voltage.

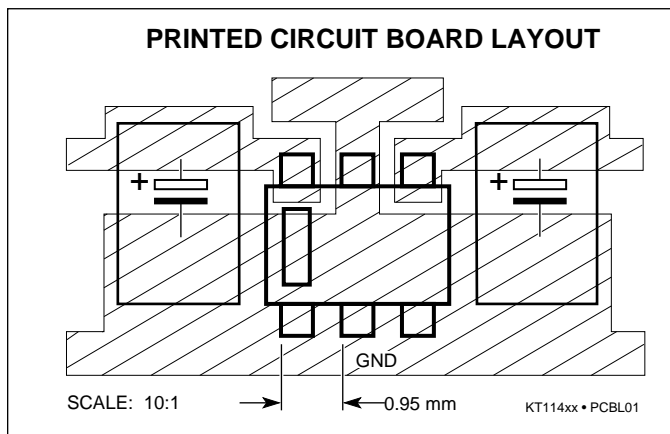

Application Hints

Maximize copper foil area connecting to all IC pins for optimum performance. Place input and output bypass capacitors close to the GND pin. For best transient behavior and lowest output impedance, use as large a capacitor value as possible. The temperature coefficient of the capacitance and Equivalent Series Resistance (ESR) should be taken into account. These parameters can influence power supply noise and ripple rejection. In extreme cases, oscillation may occur. In order to maintain stability, the output bypass capacitor value should be minimum 2.2 μF for a Tantalum electrolytic or 4.7 μF for an Aluminum electrolytic.

Handling Molded Resin Packages

All plastic molded packages absorb some moisture from the air. If moisture absorption occurs prior to soldering the device into the printed circuit board, increased separation of the lead from the plastic molding may occur, degrading the moisture barrier characteristics of the device. This property of plastic molding compounds should not be overlooked, particularly in the case of very small packages, where the plastic is very thin.

In order to preserve the original moisture barrier properties of the package, devices are stored and shipped in moisture proof bags, filled with dry air. The bags should not be opened or damaged prior to the actual use of the devices. If this is unavoidable, the devices should be stored in a low relative humidity environment (40 to 65%) or in an enclosed environment with desiccant.

TYPICAL APPLICATIONS (CONT.)

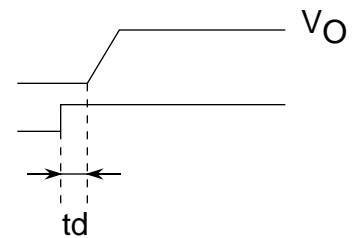
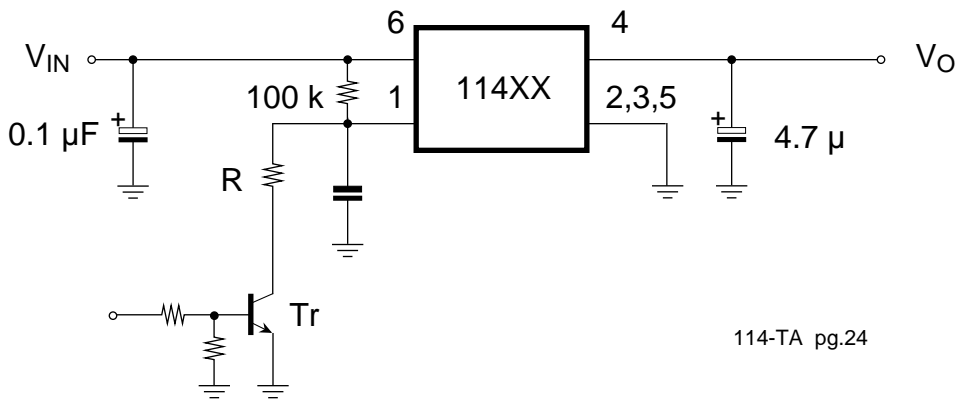
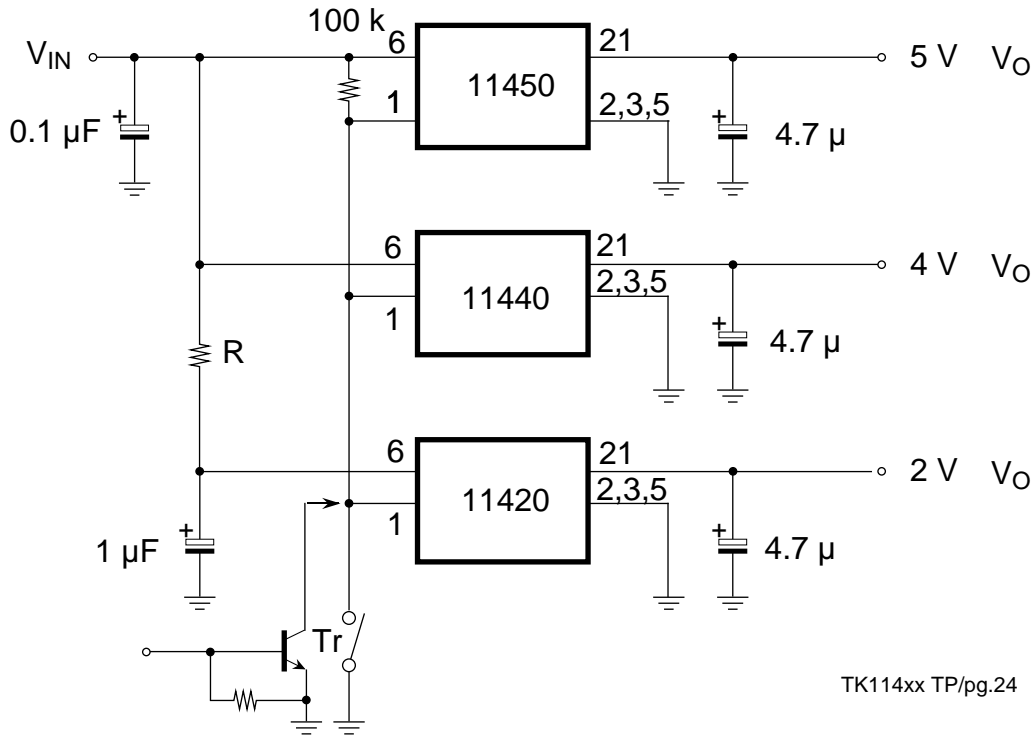

PACKAGE OUTLINE

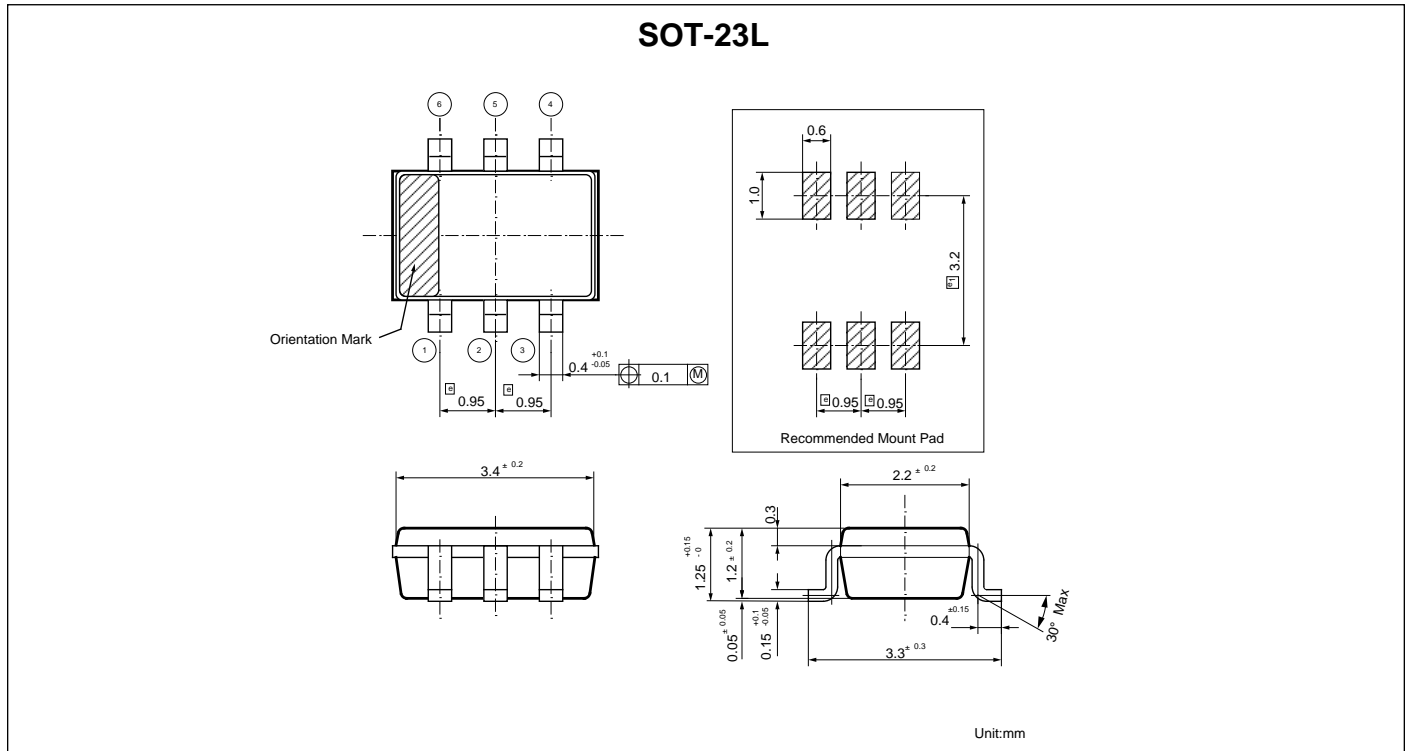

The information furnished by TOKO, Inc. is believed to be accurate and reliable. However, TOKO reserves the right to make changes or improvements in the design, specification or manufacture of its products without further notice. TOKO does not assume any liability arising from the application or use of any product or circuit described herein, nor for any infringements of patents or other rights of third parties which may result from the use of its products. No license is granted by implication or otherwise under any patent or patent rights of TOKO, Inc.



YOUR LOCAL REPRESENTATIVE IS:



TOKO, Inc.
 1-17, Higashi-yukigaya 2-chome
 Ohta-ku, Tokyo
 145 Japan
 Tel: (03) 3727-1161
 Fax: (03) 3728-4690, 4697